

# SURPRISE

## PLUS



# 8x

1380 x 193 x 8mm  
= **2,131 m<sup>2</sup>**

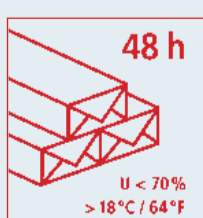
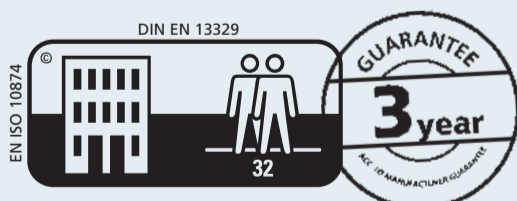
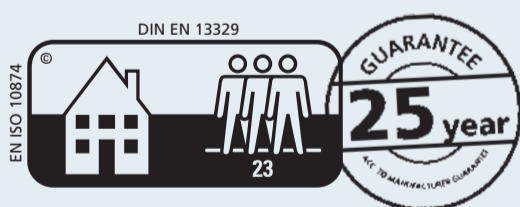

Institut Bauen  
und Umwelt e.V.  
Institute Construction  
and Environment e.V.



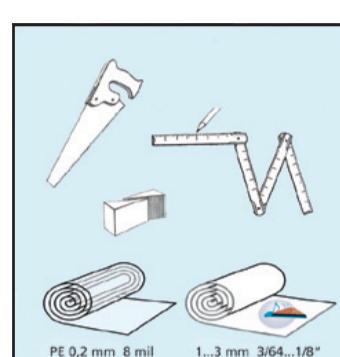
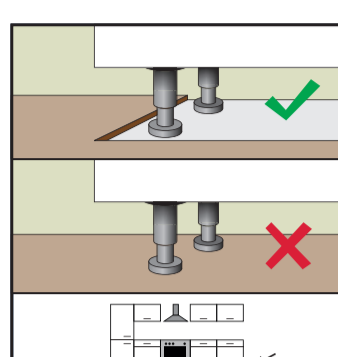
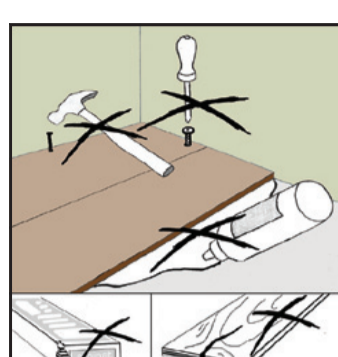
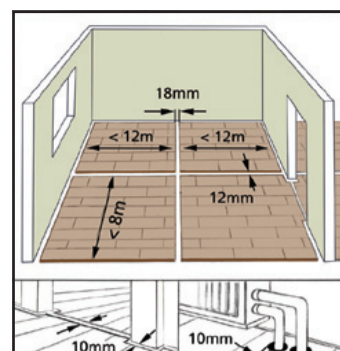
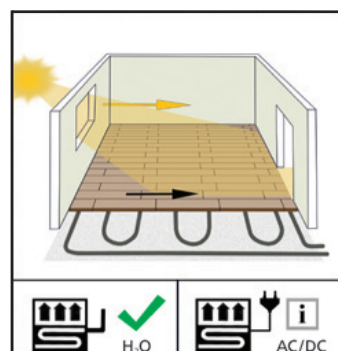
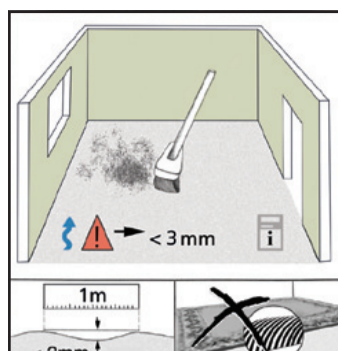

## INSTALLATION

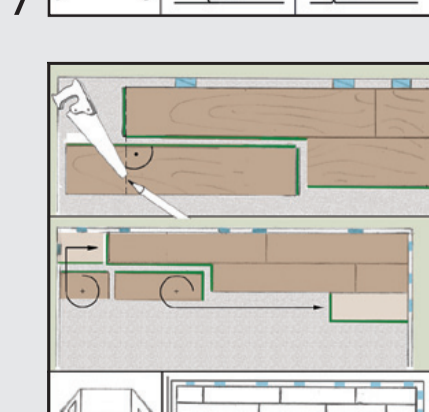
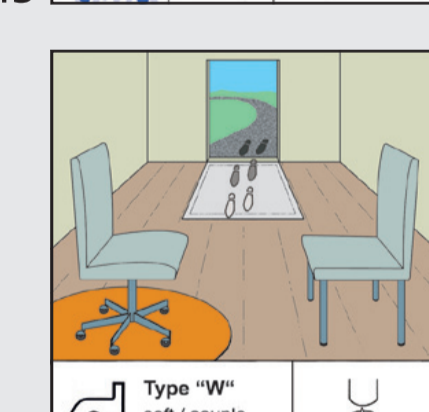
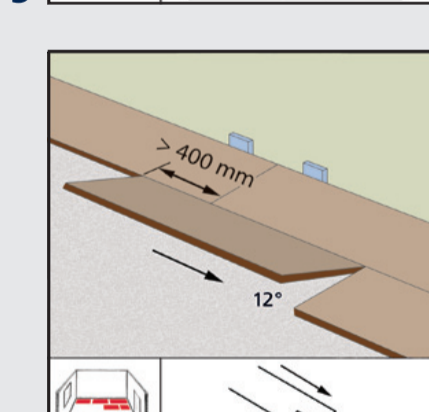
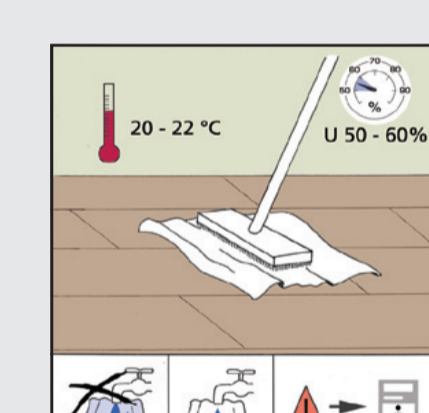
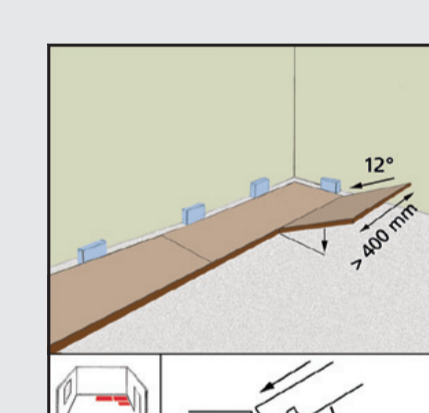
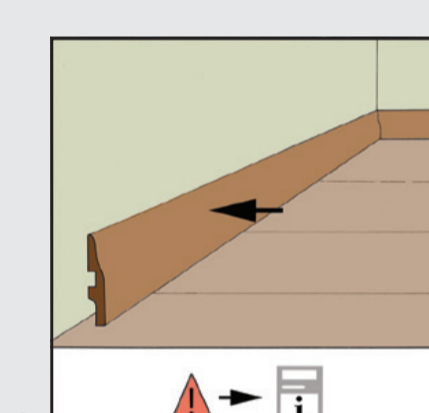
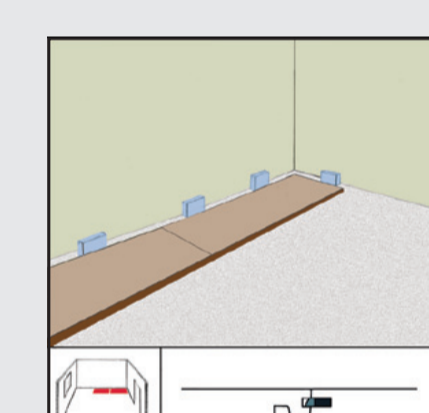
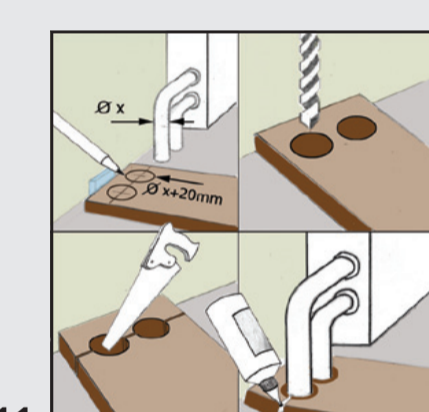
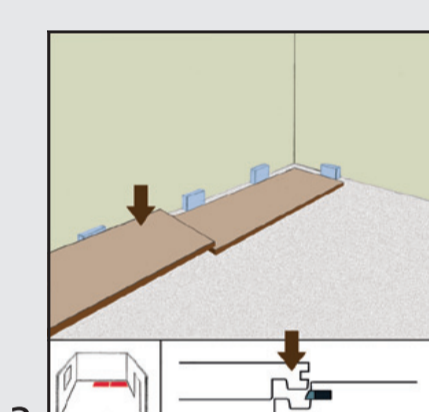
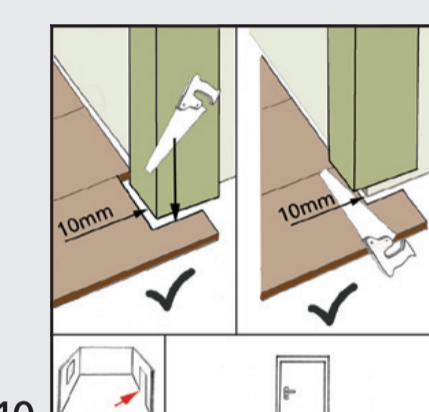
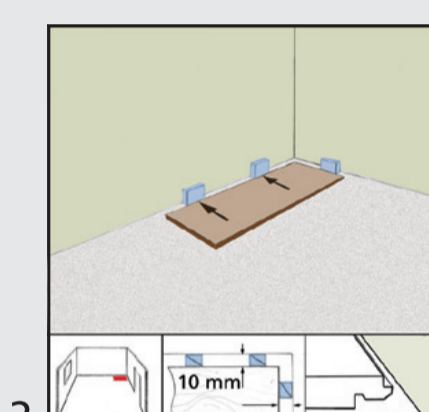
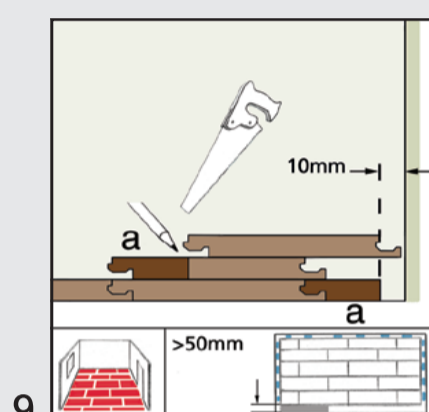
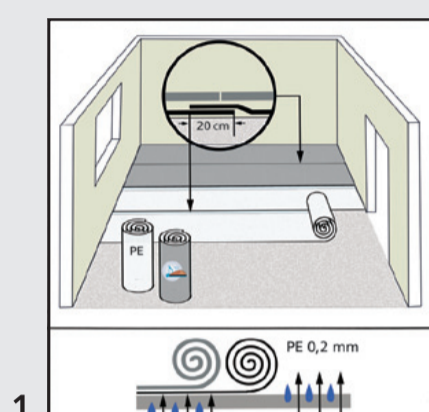

## REMOVAL

