

LOUNGE CHAIR

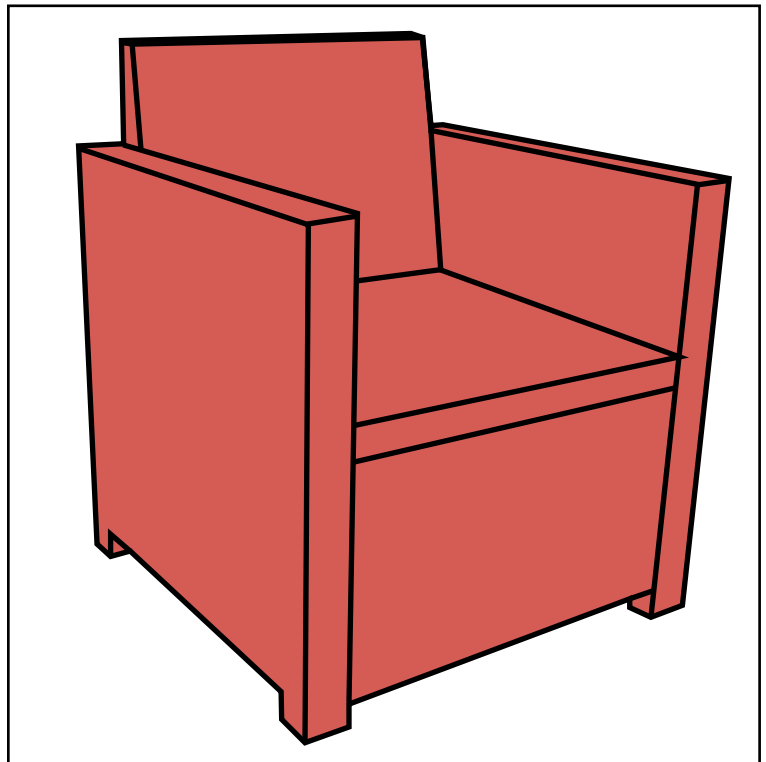

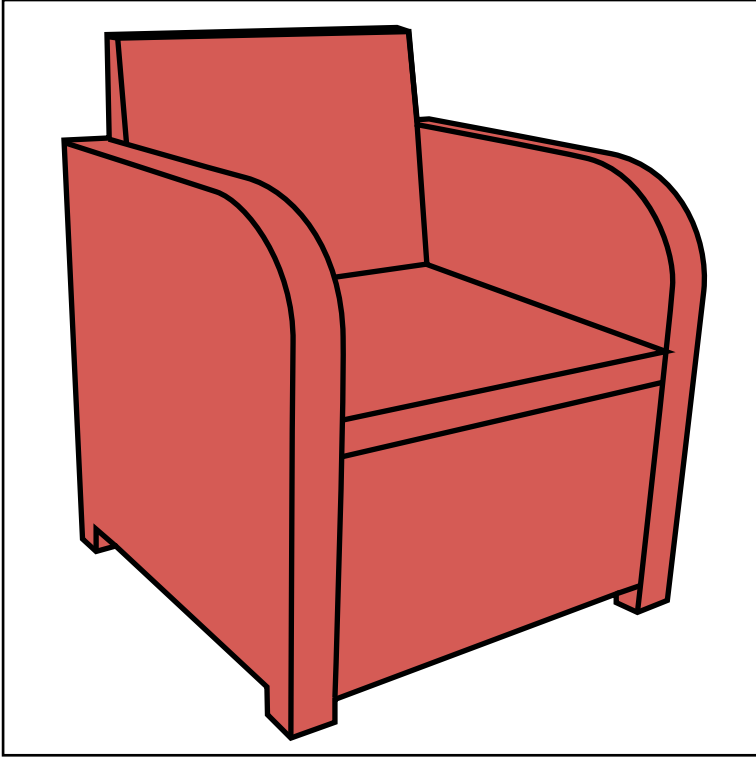

NEN 581

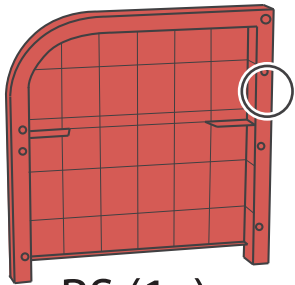
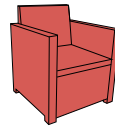
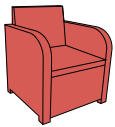

RS (1x)

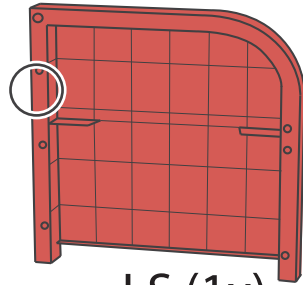

LS (1x)

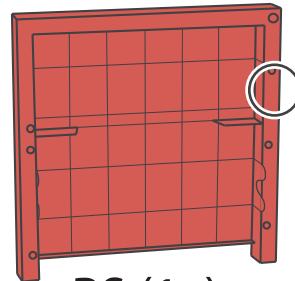

RS (1x)

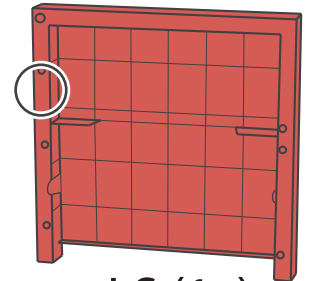

LS (1x)

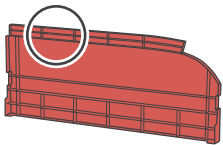

SCR (1x)

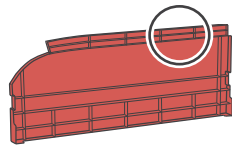

SCL (1x)

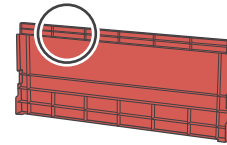

SC (2x)

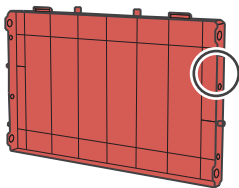

F1 (1x)

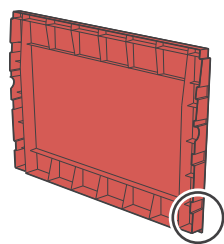

BC1 (1x)

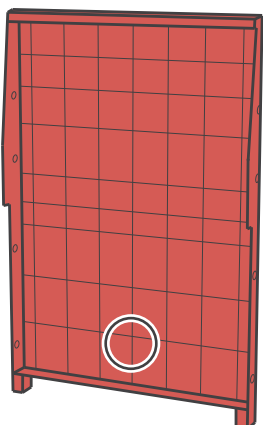

B1 (1x)

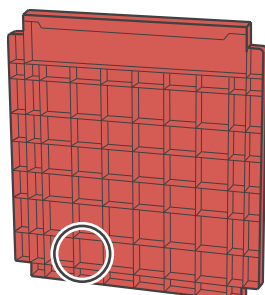

S1 (1x)

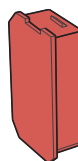

NA (2x)

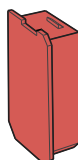

NB (2x)

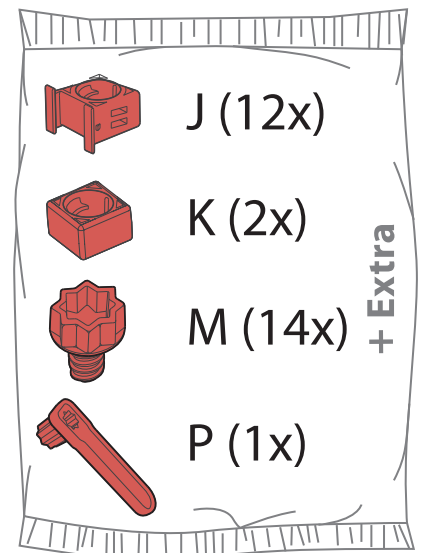

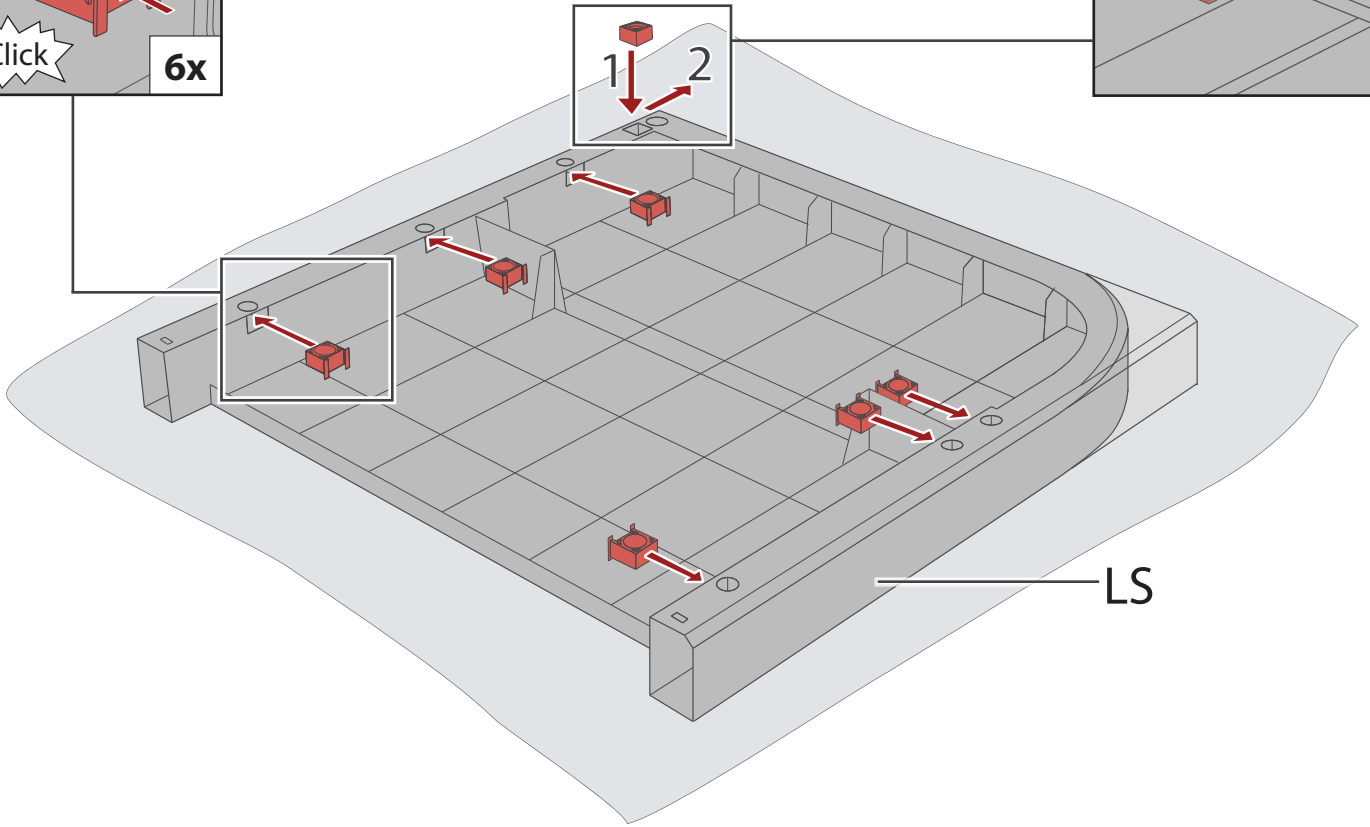
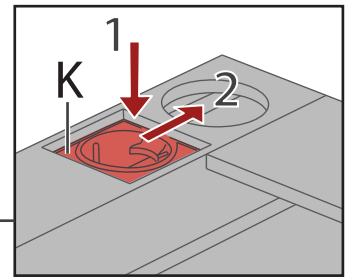
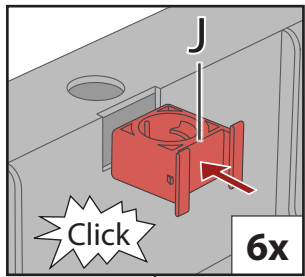

1

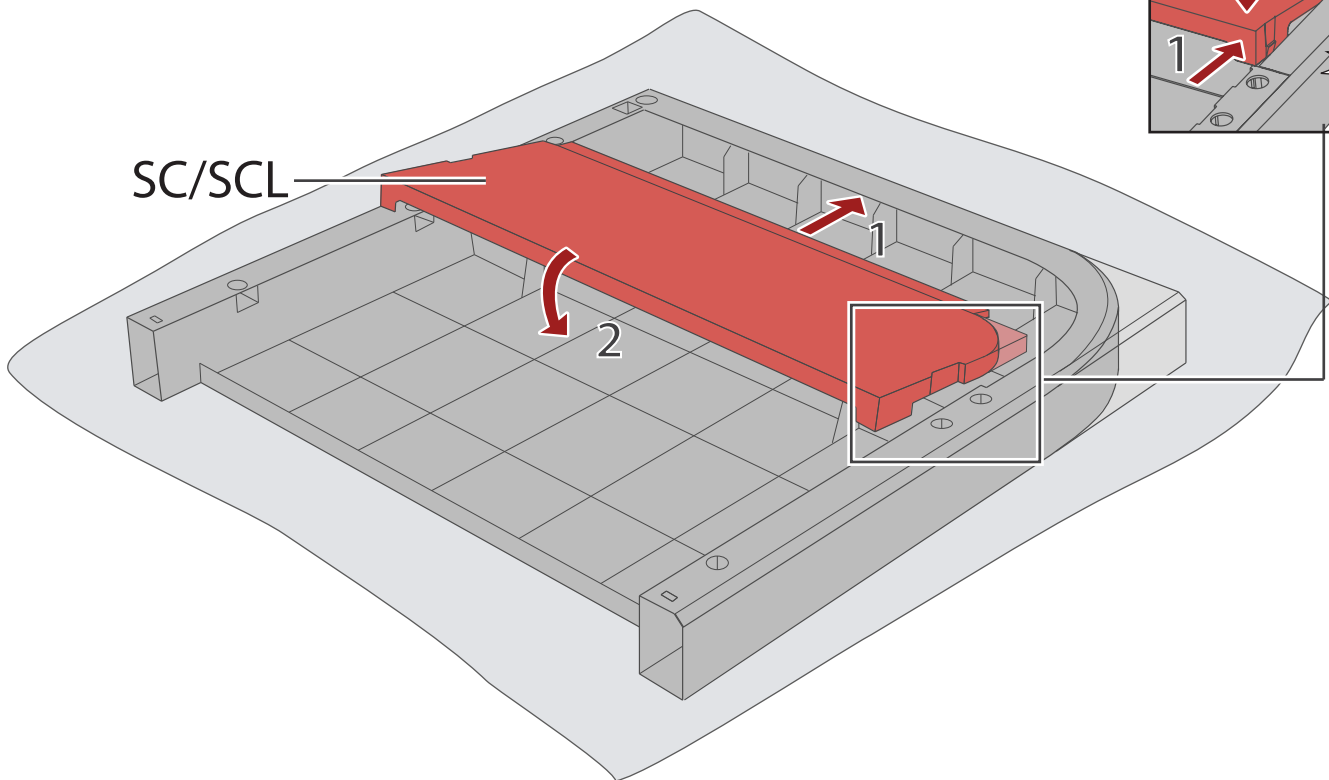
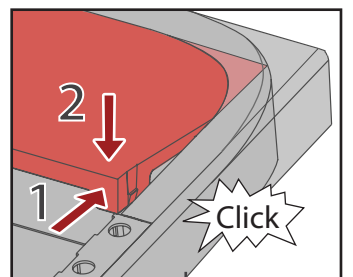

2

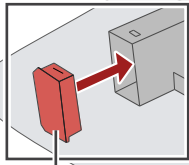
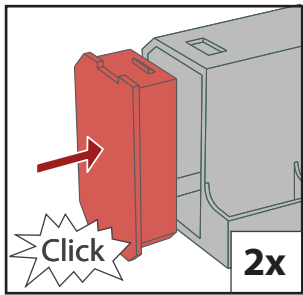

NA

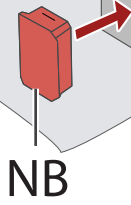

NB

3

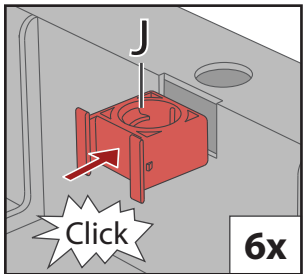

Click

6x

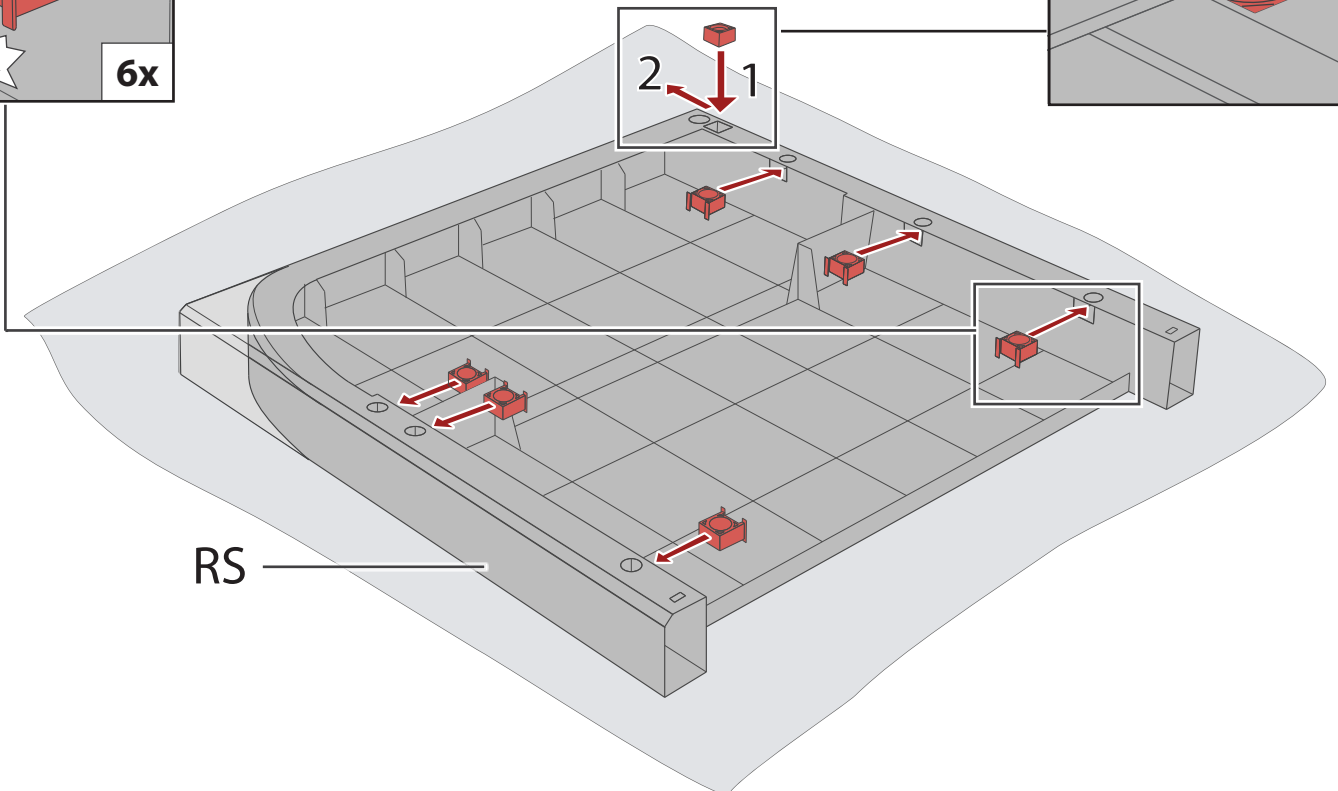

RS

4

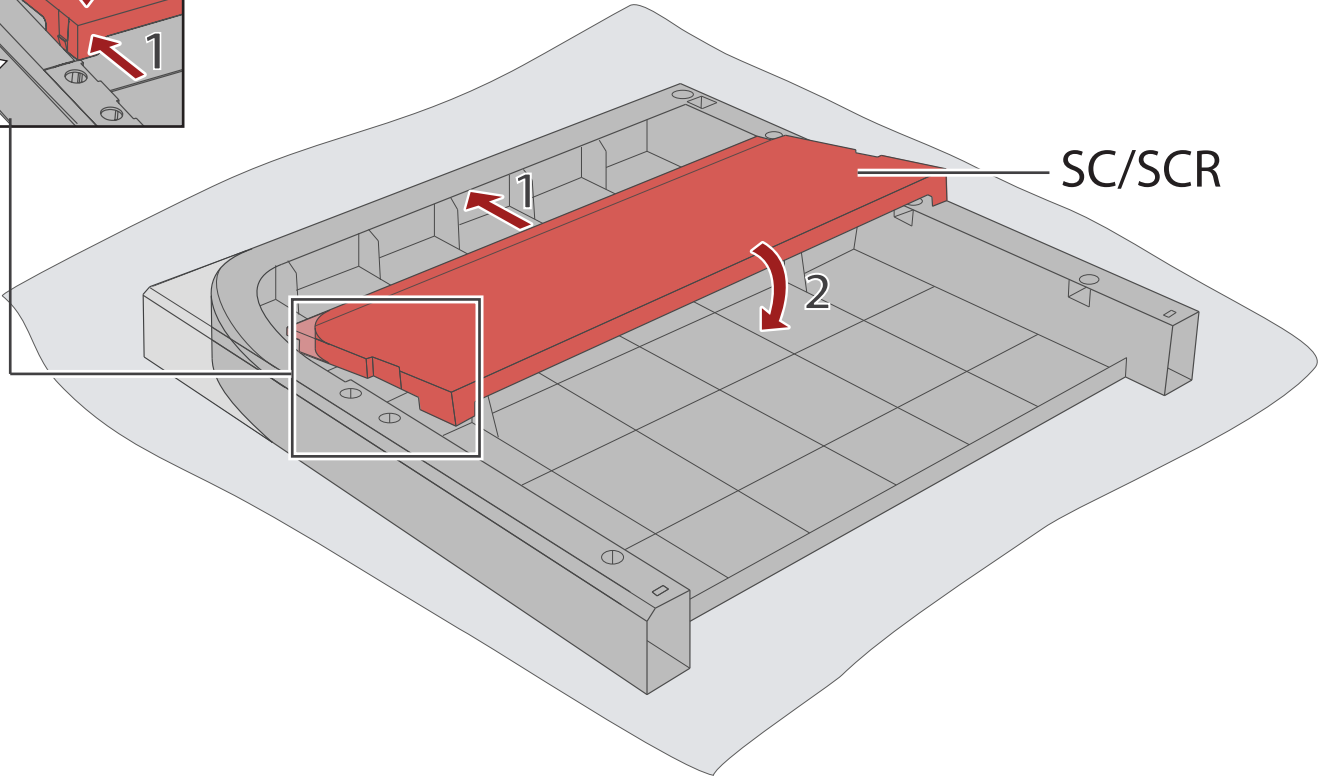
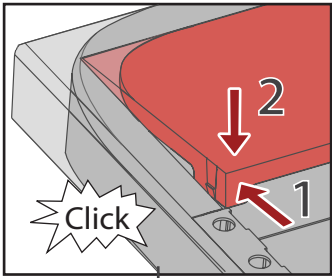

5

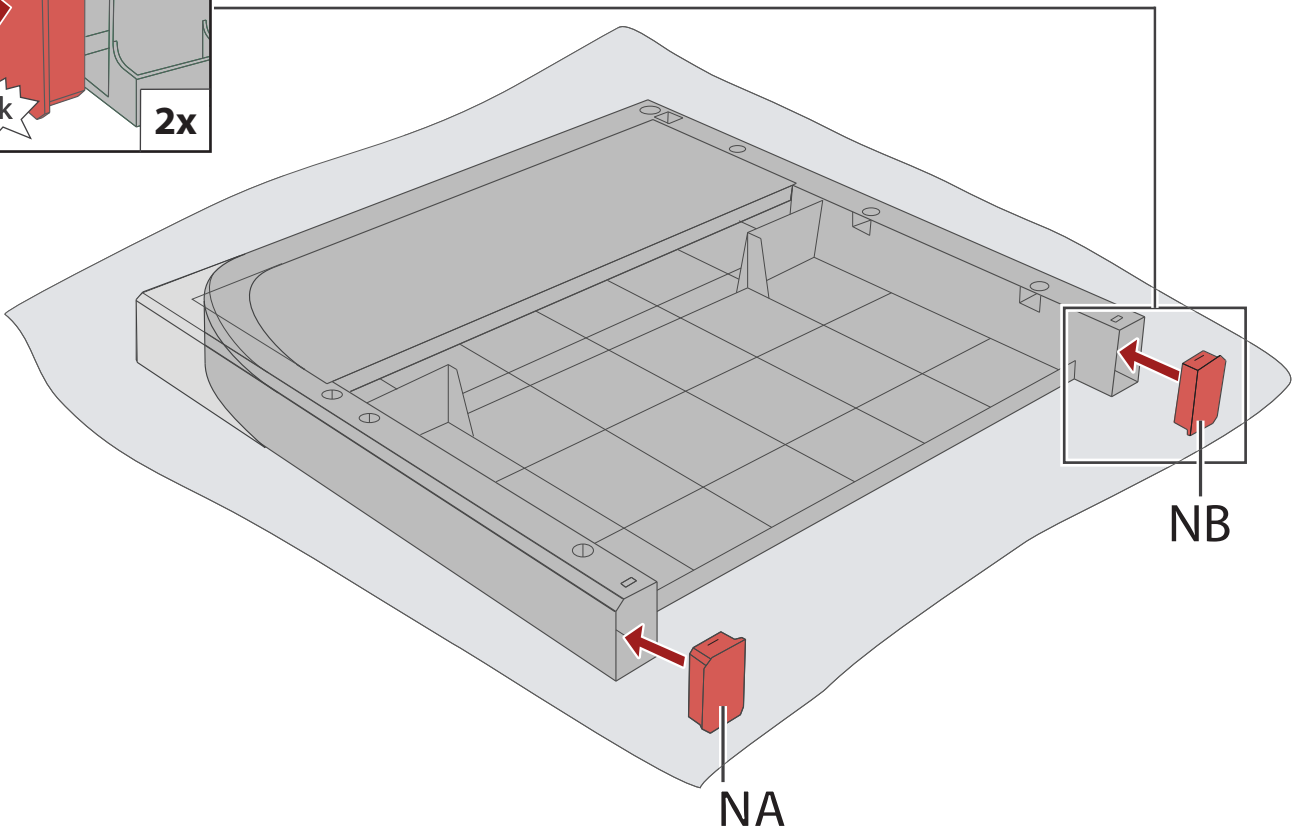
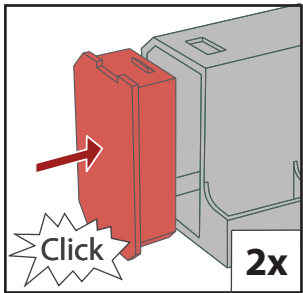

6

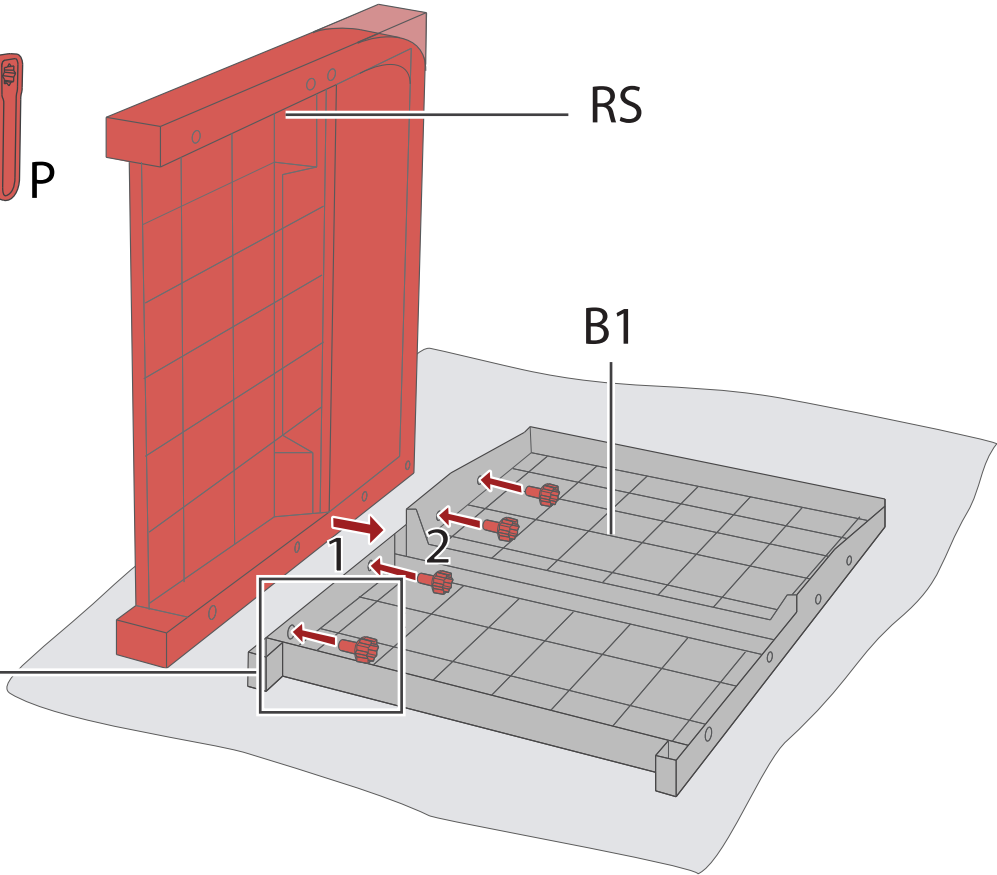
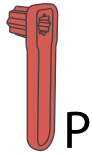
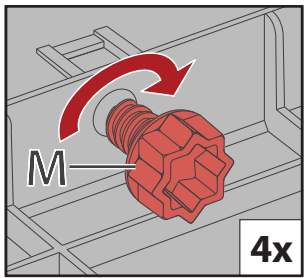

7

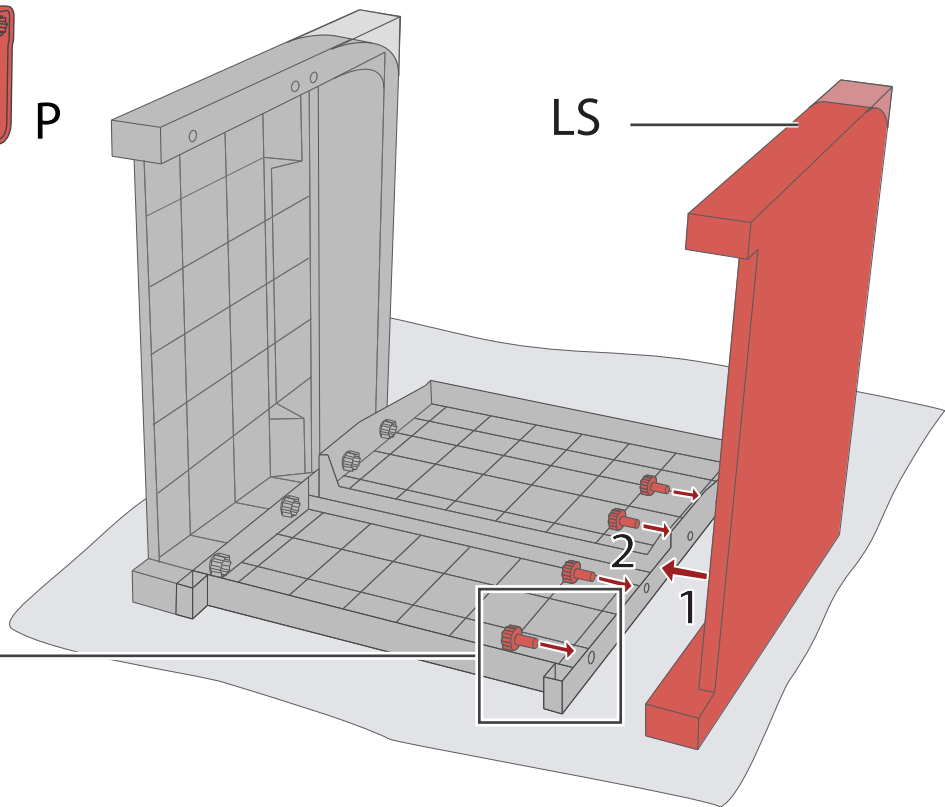
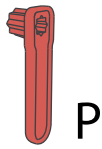
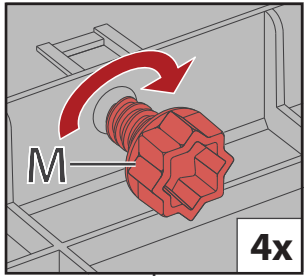

8

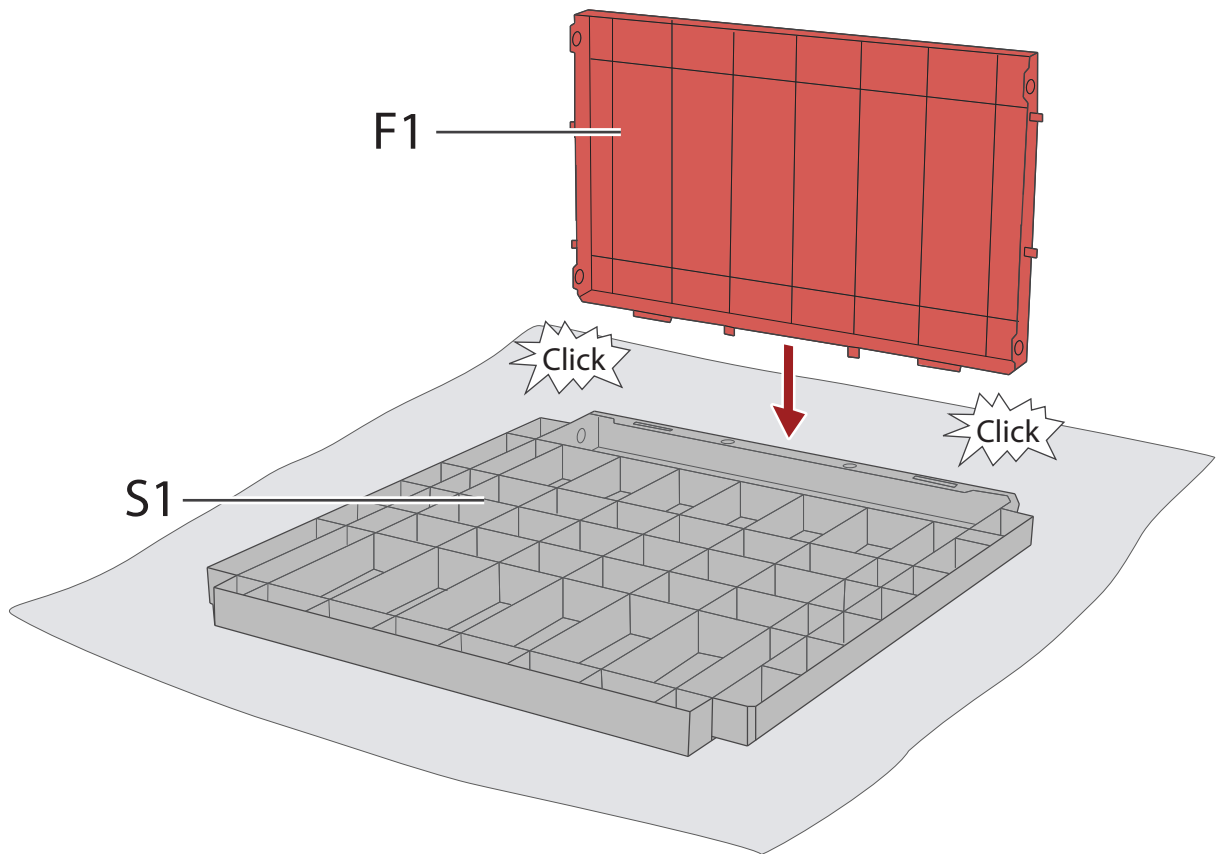

9

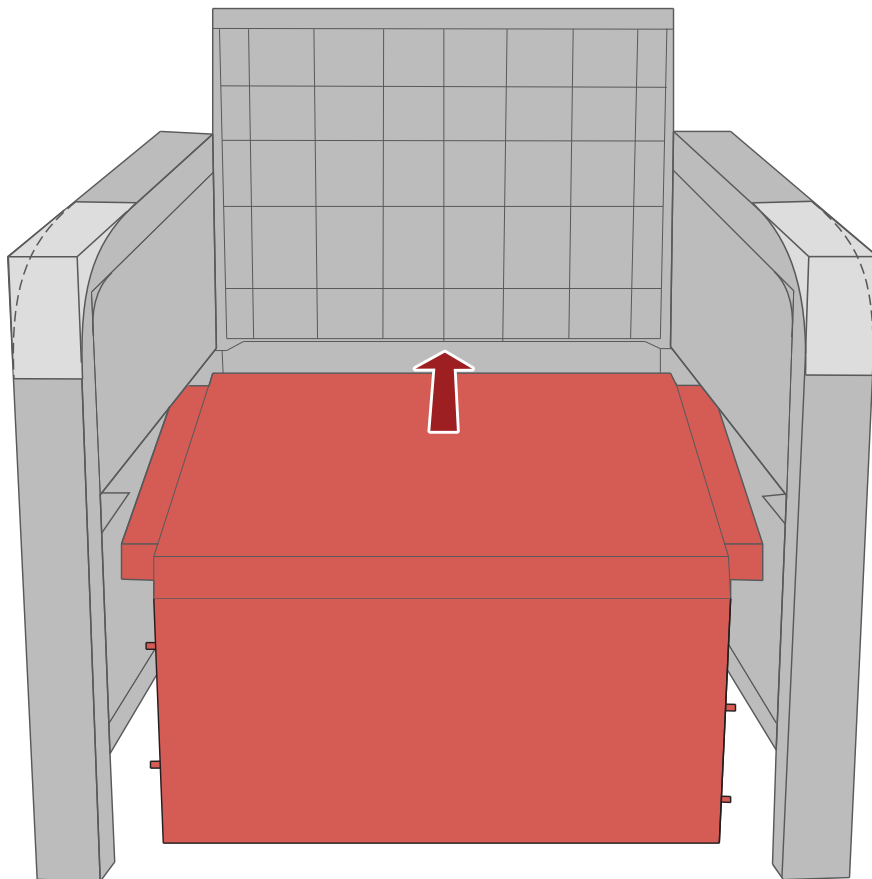

10

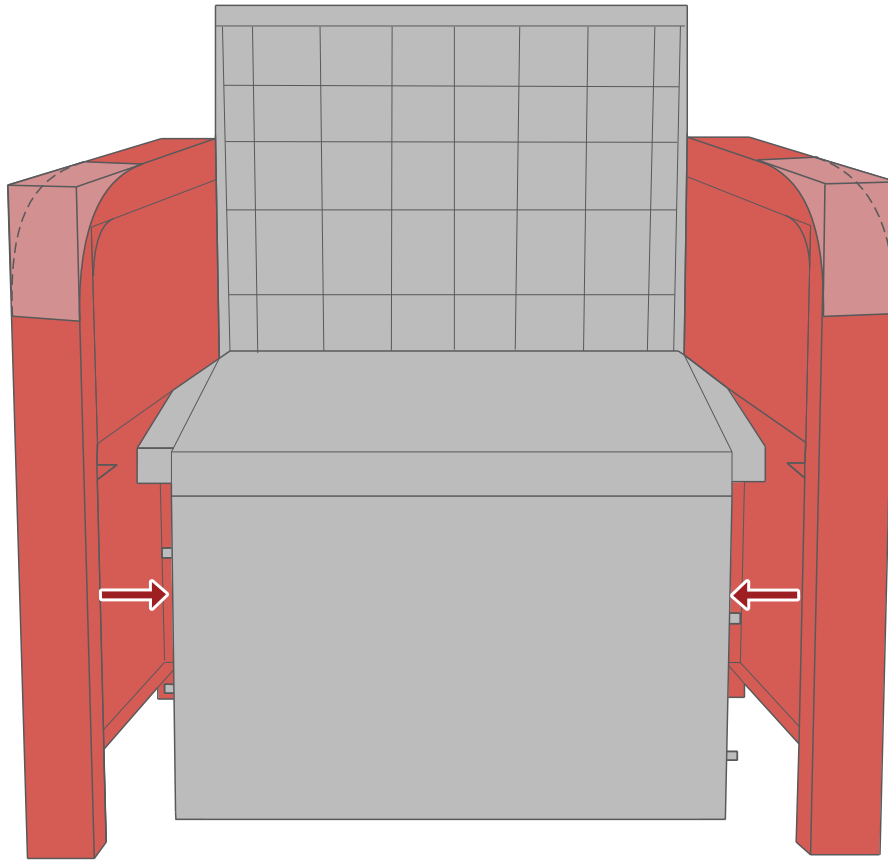

11

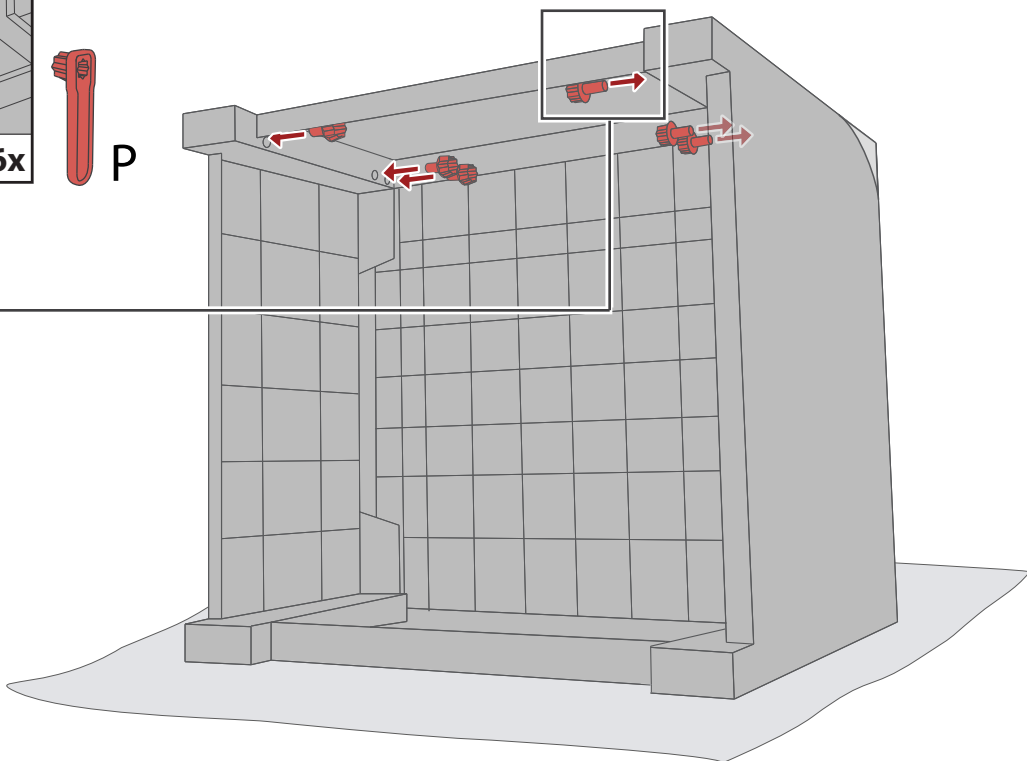
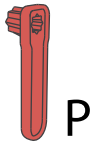
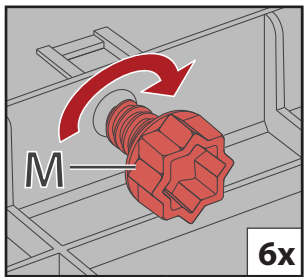

12

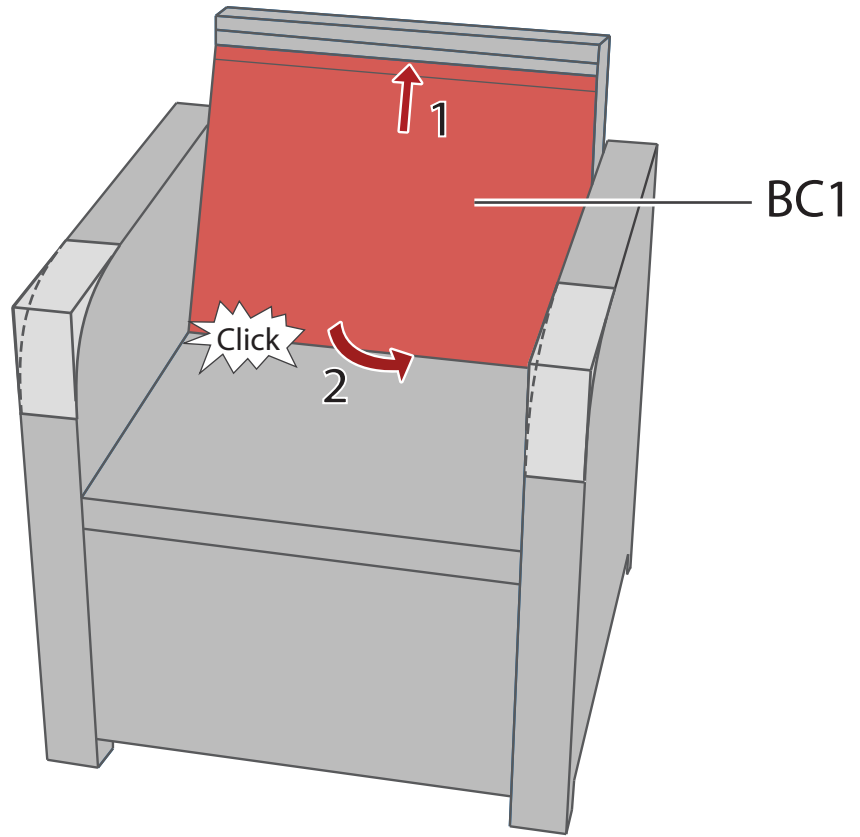
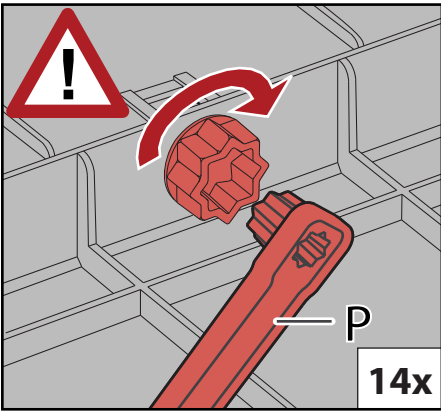

13

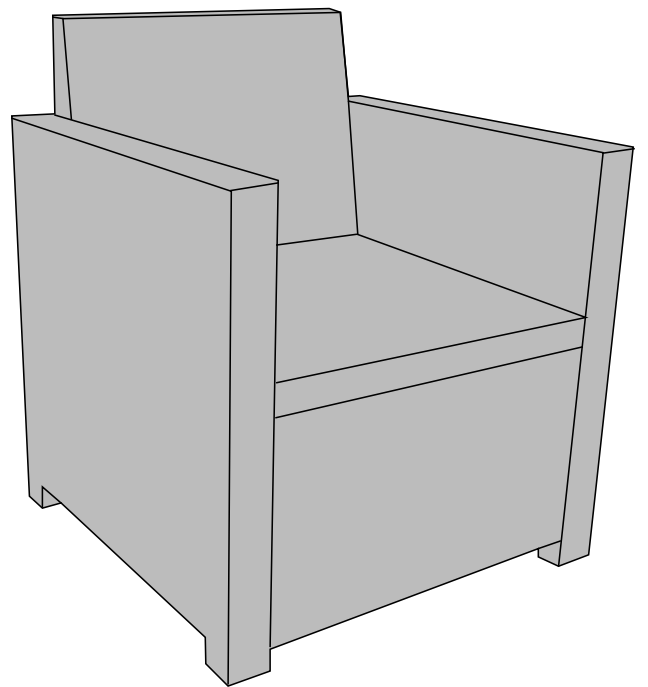
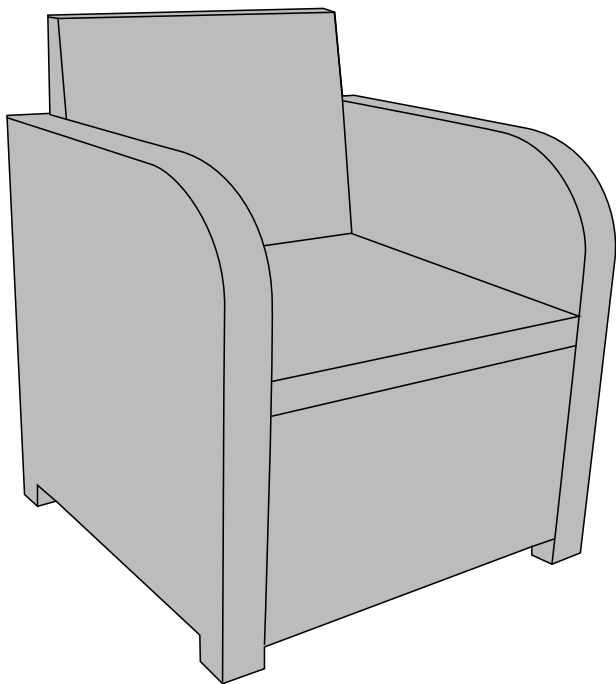

14

LOUNGE SOFA

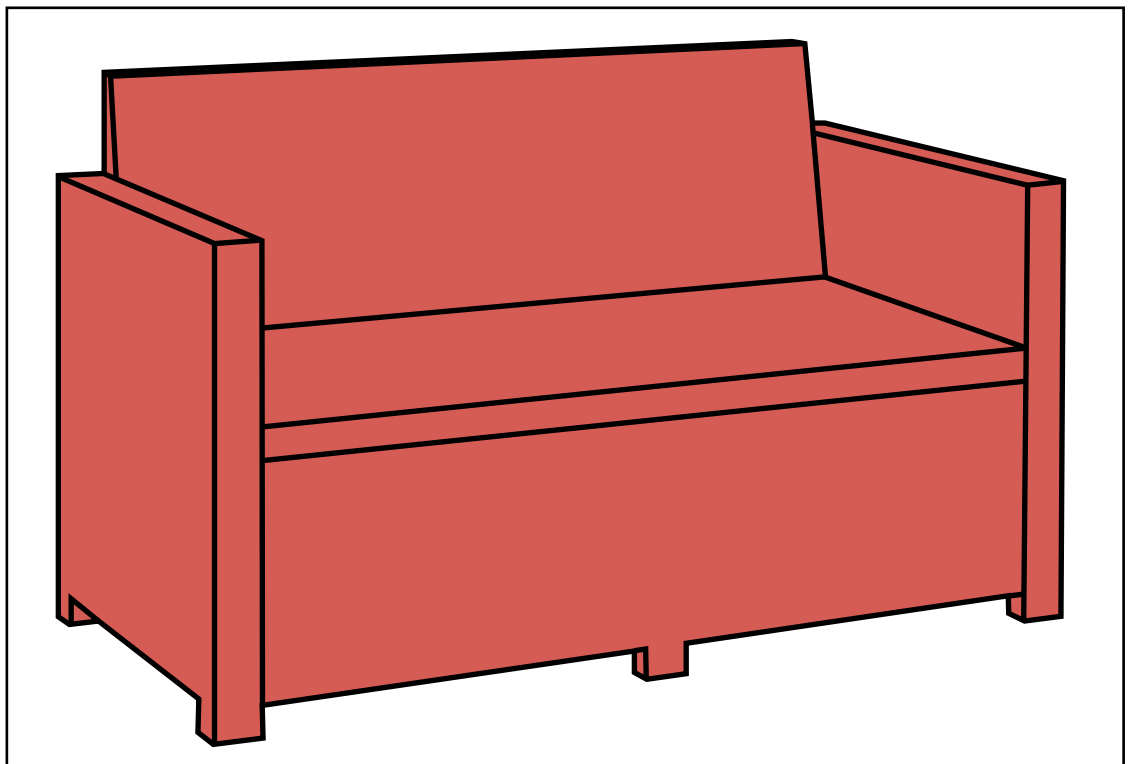
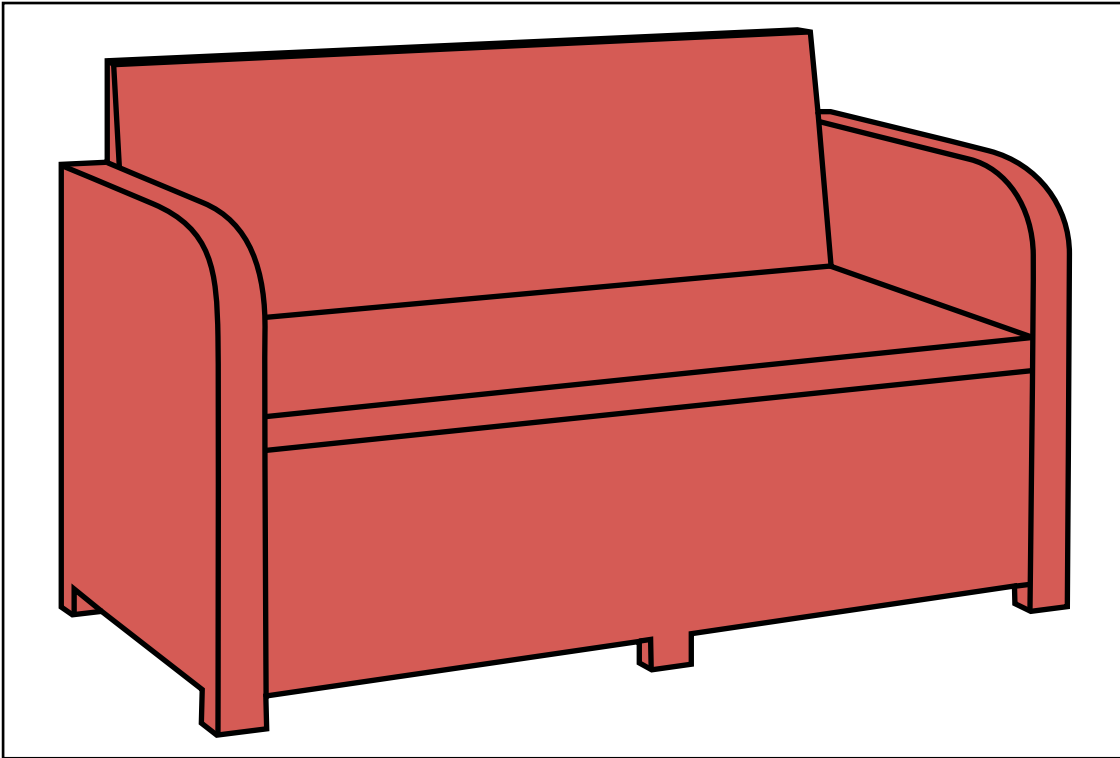



NEN 581

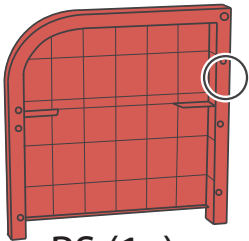
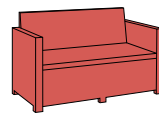
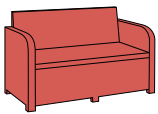

RS (1x)

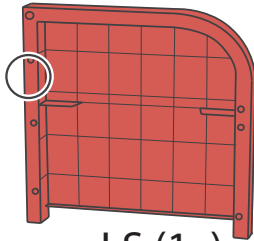

LS (1x)

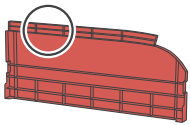

SCR (1x)

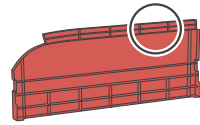

SCL (1x)

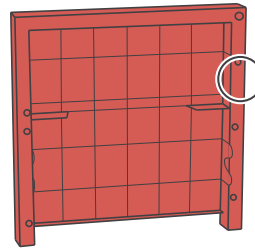

RS (1x)

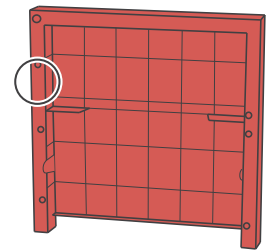

LS (1x)

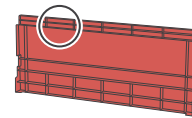

SC (2x)

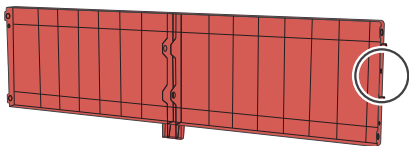

FCS1 (1x)

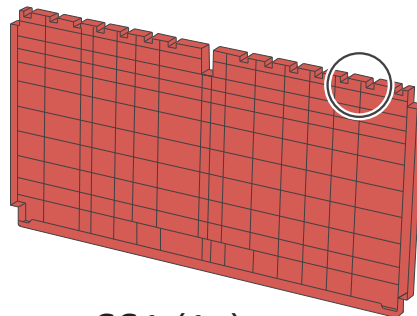

SS1 (1x)

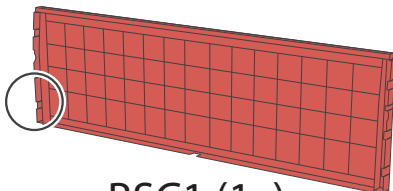

BSC1 (1x)

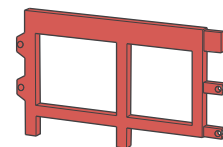

Q (1x)



R (1x)

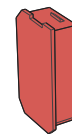

NA (2x)

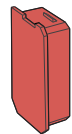

NB (2x)

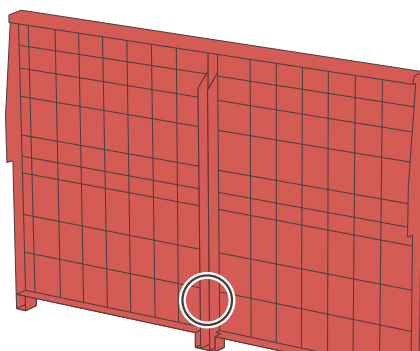

BS1 (1x)

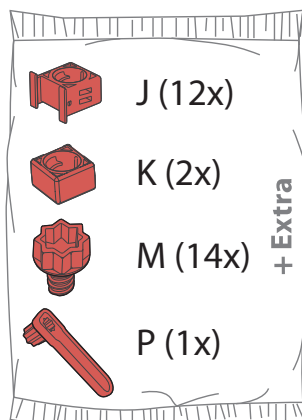

J (12x)



K (2x)



M (14x)



P (1x)

+ Extra



K (6x)



M (6x)



P (1x)

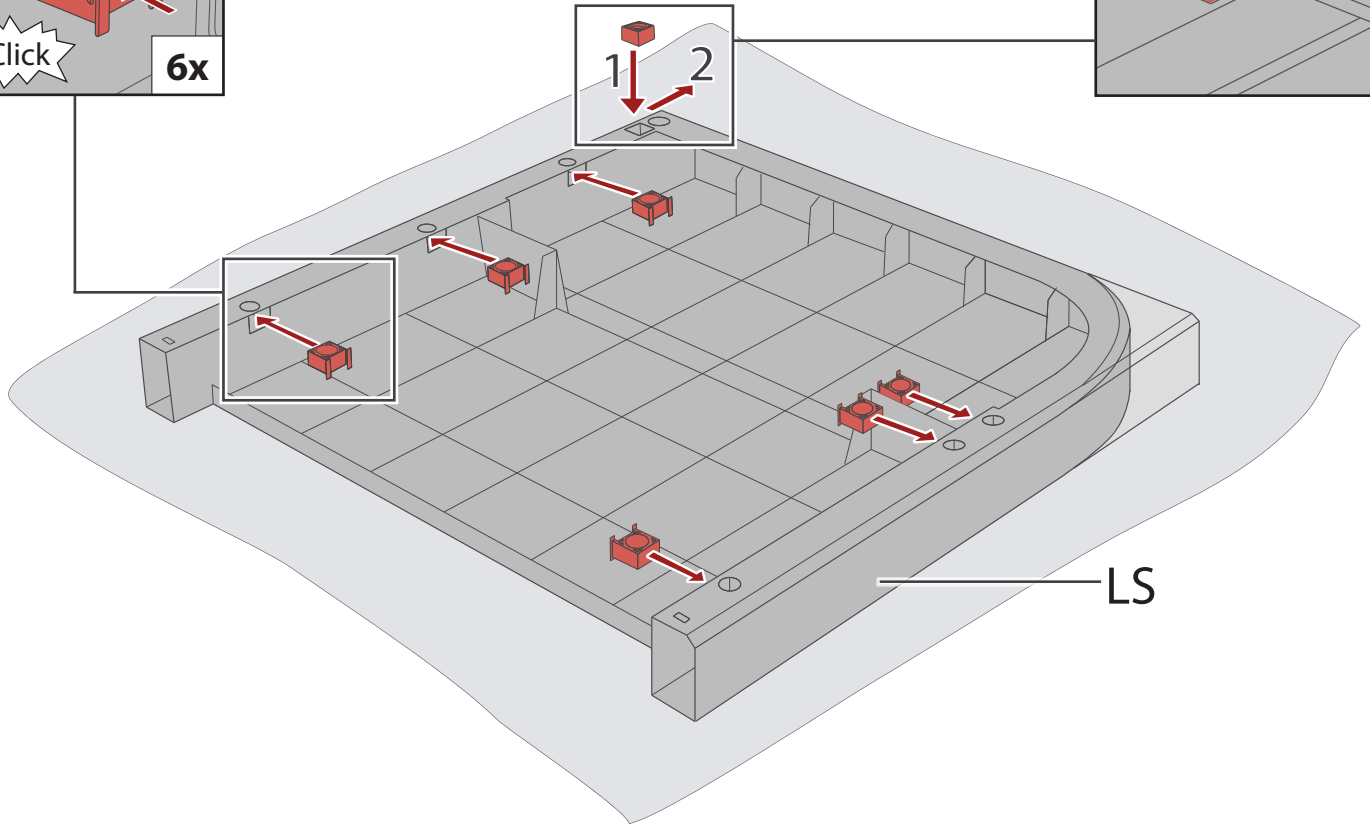
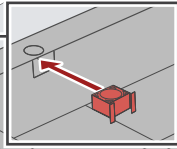
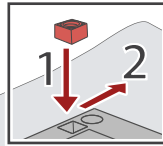
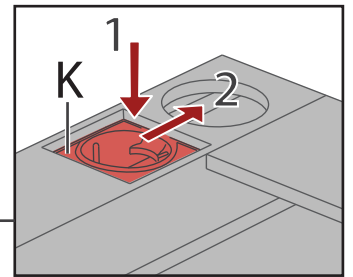
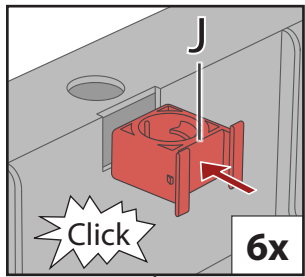

1

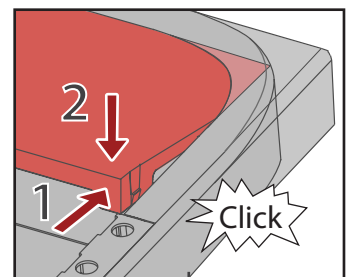

SC/SCL

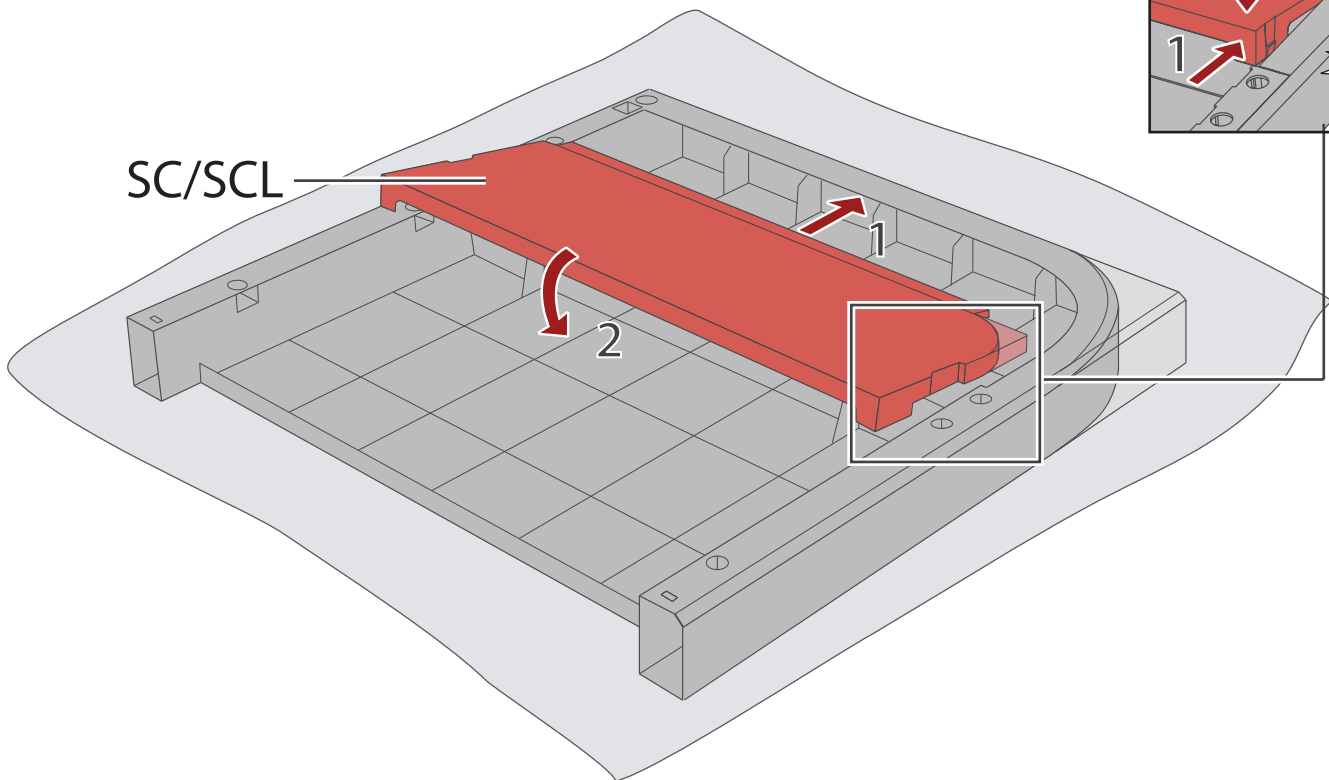

2

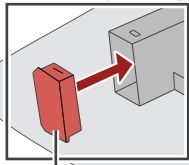
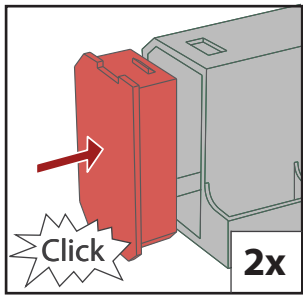

NA



NB

3

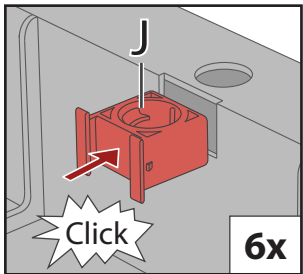

Click

6x

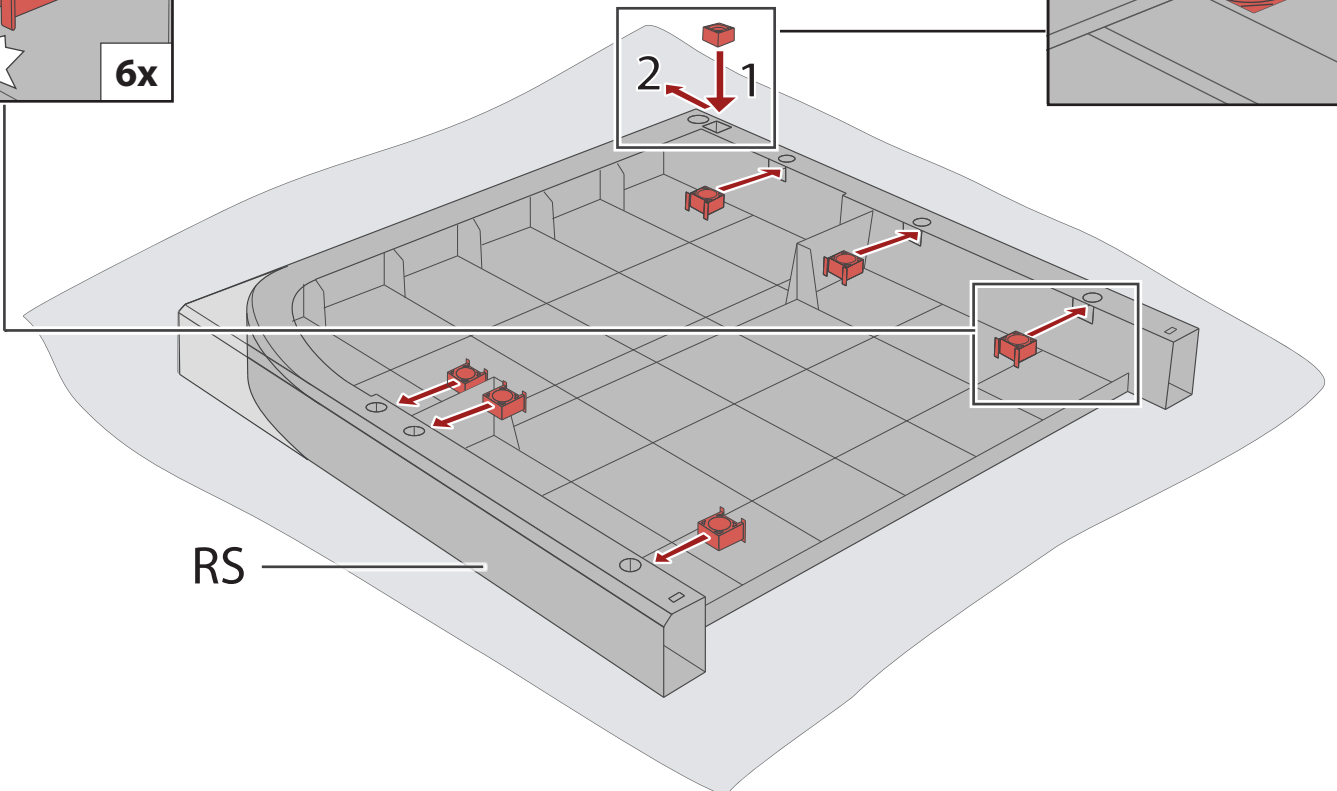

RS

4

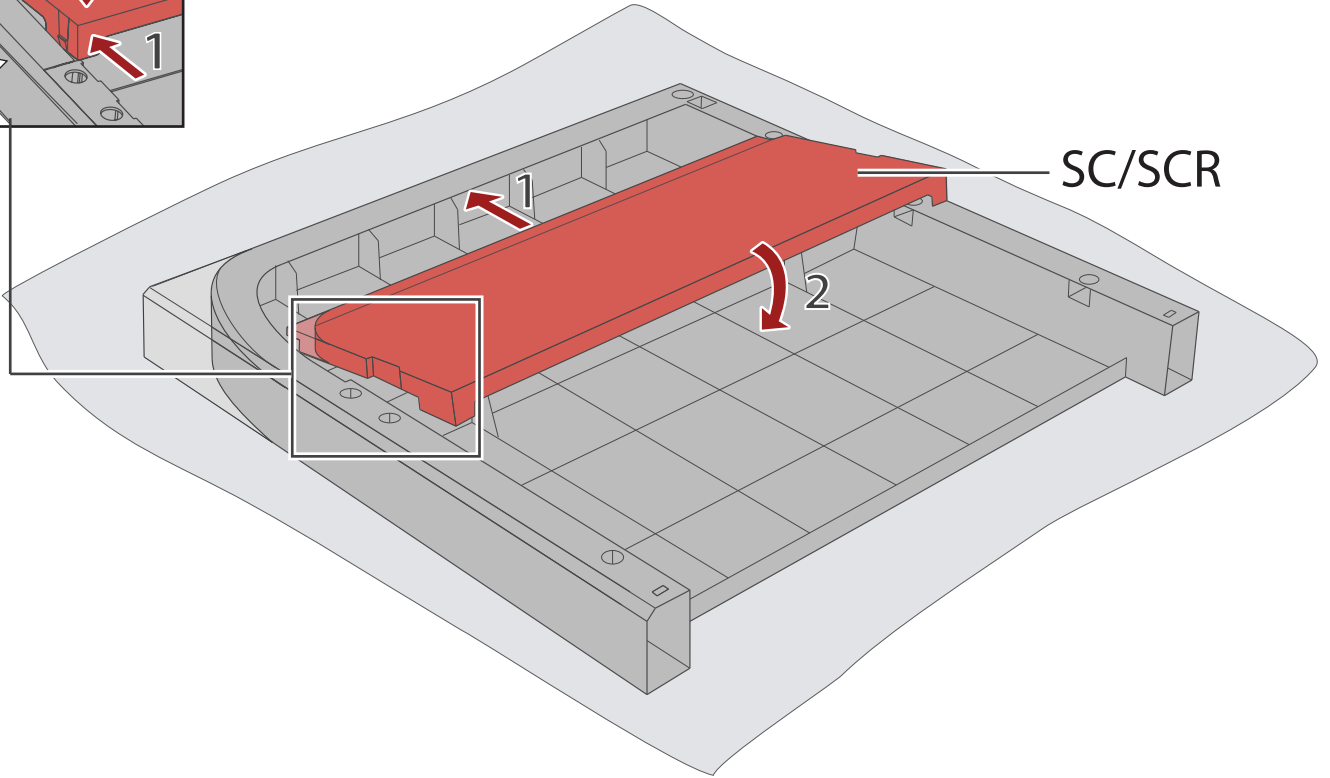
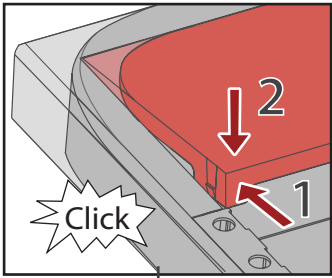

5

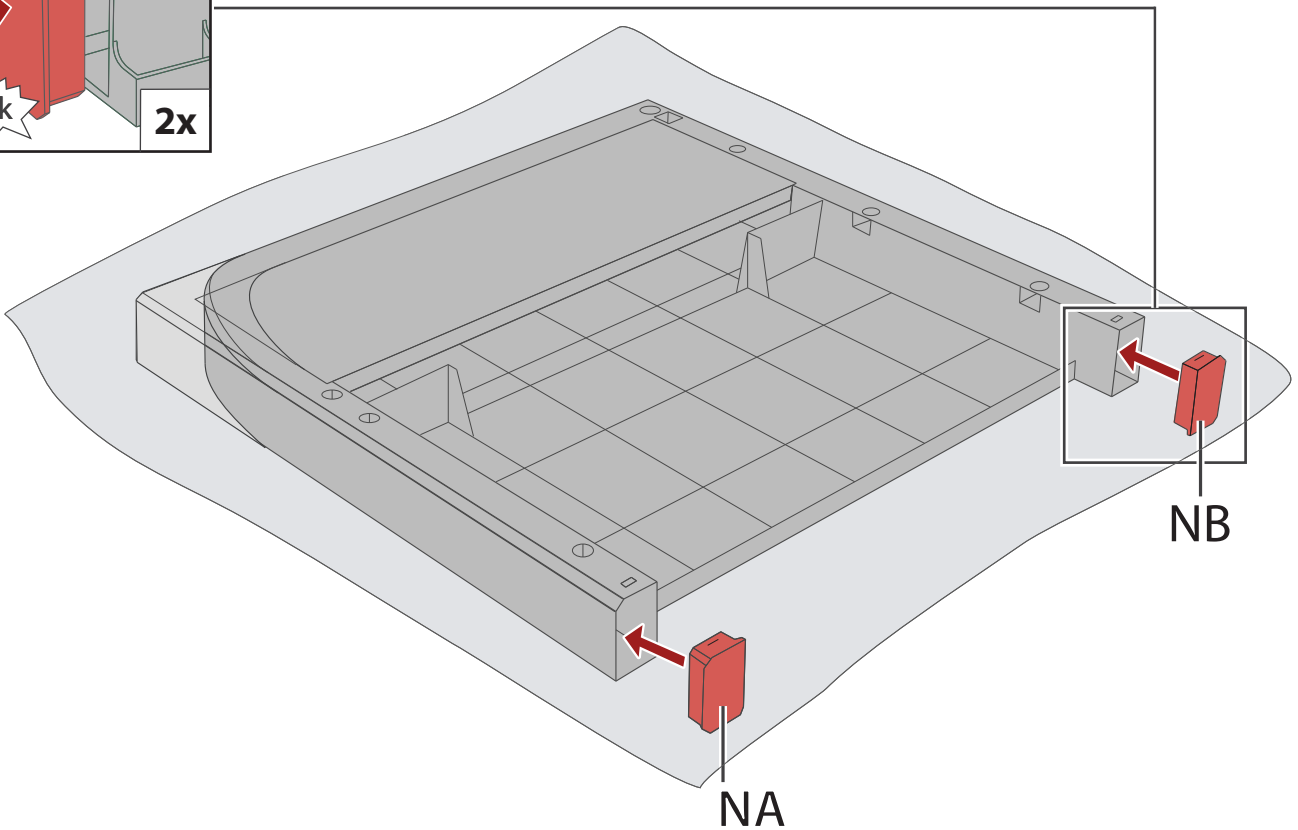
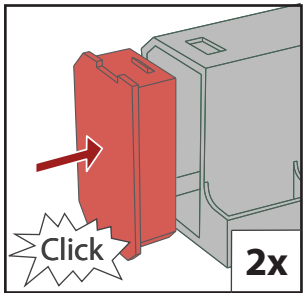

6

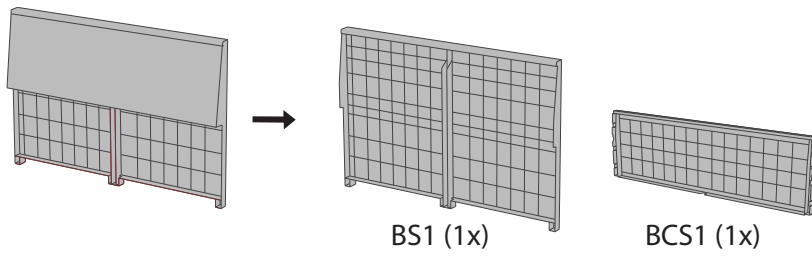
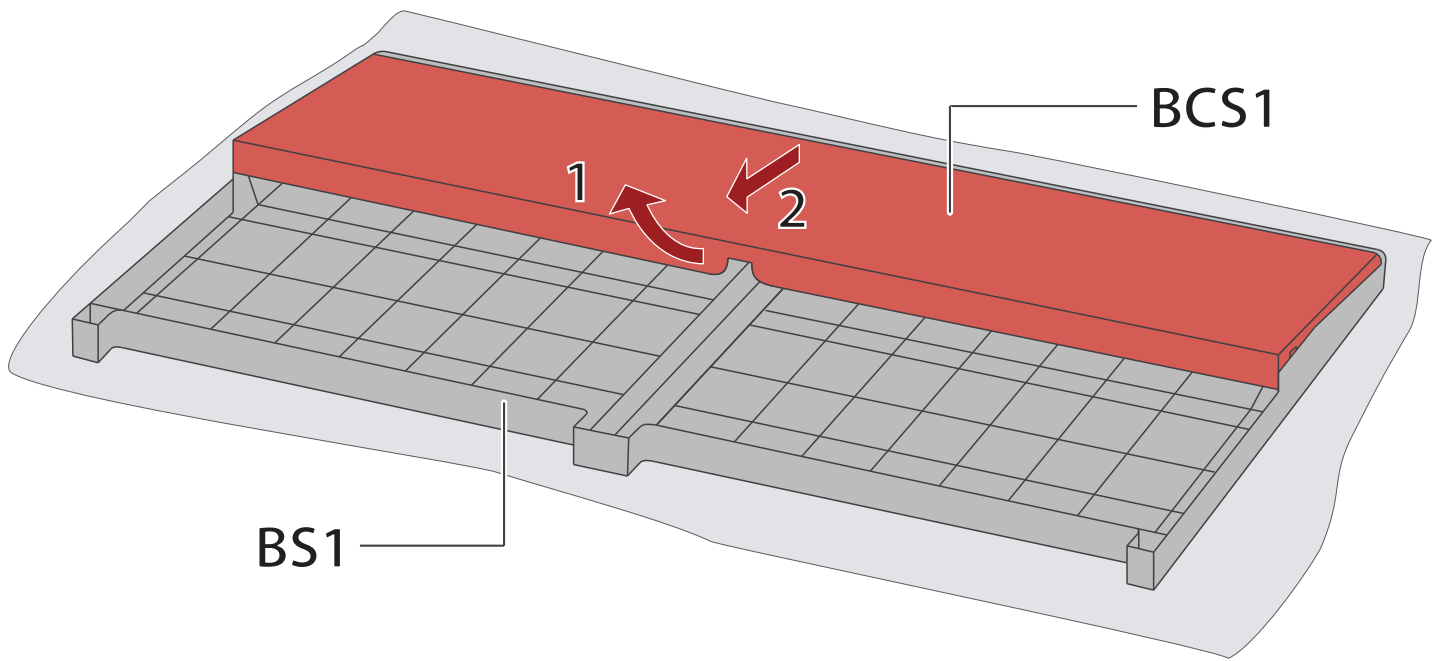

7

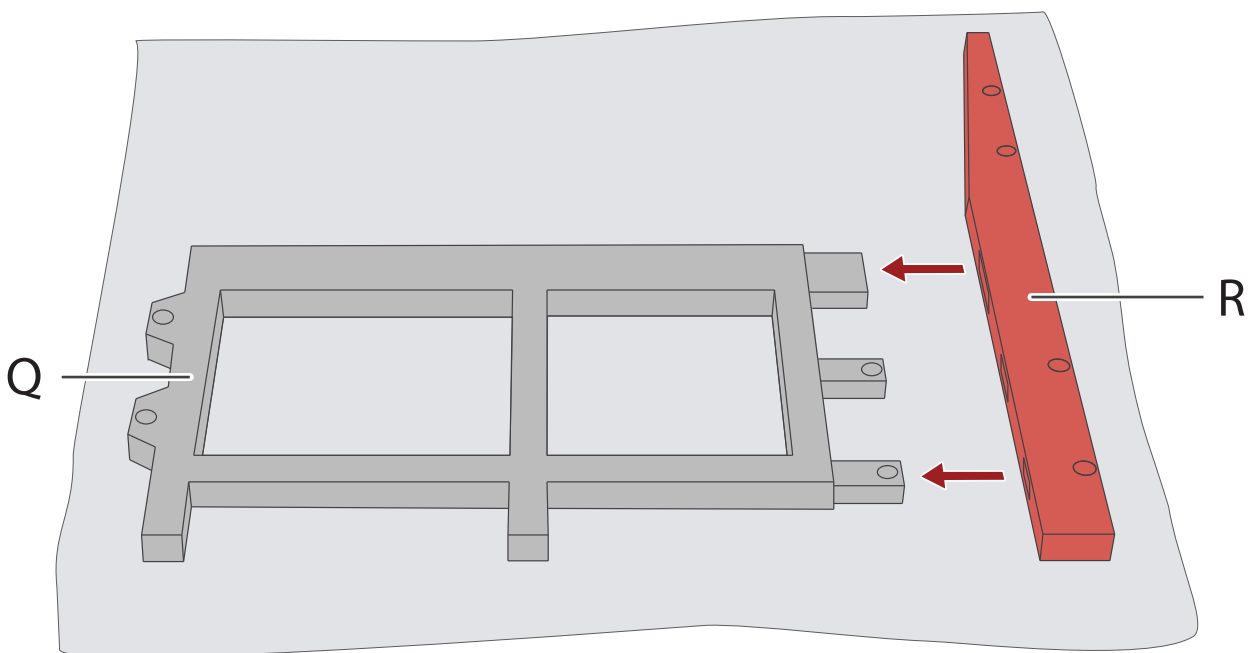

8

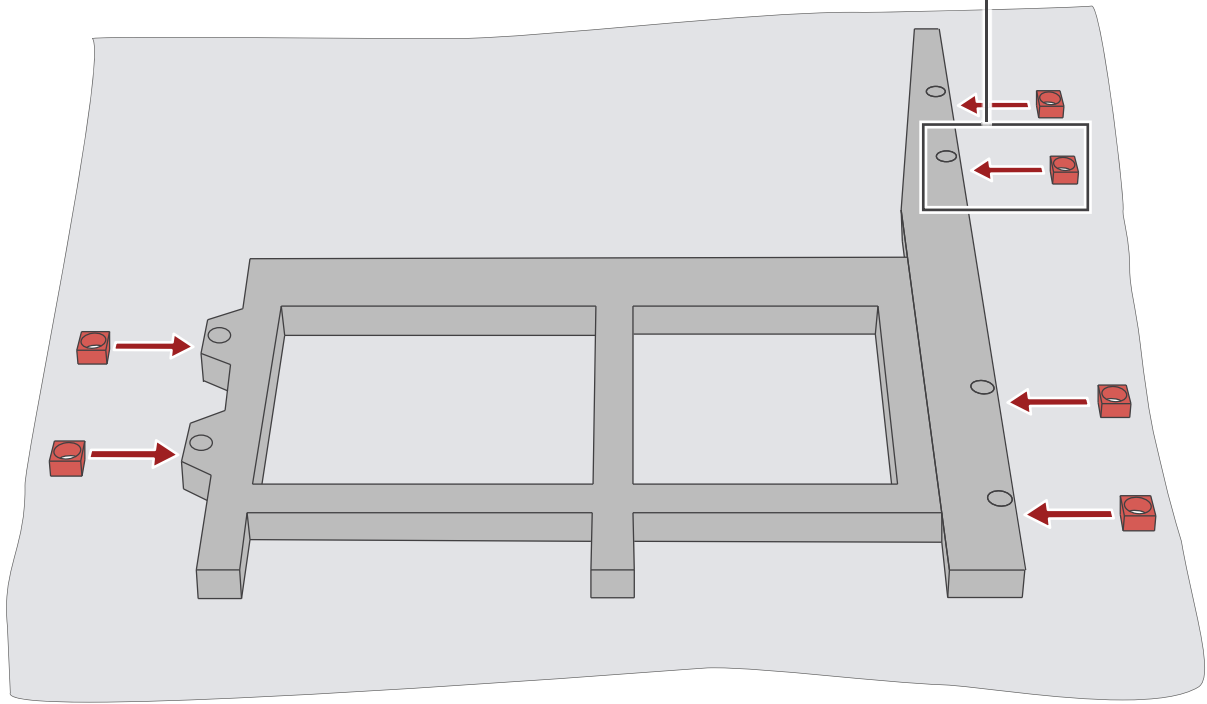
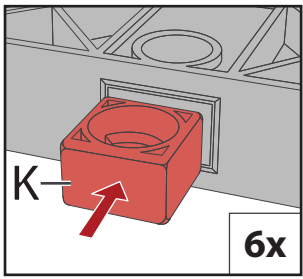

9

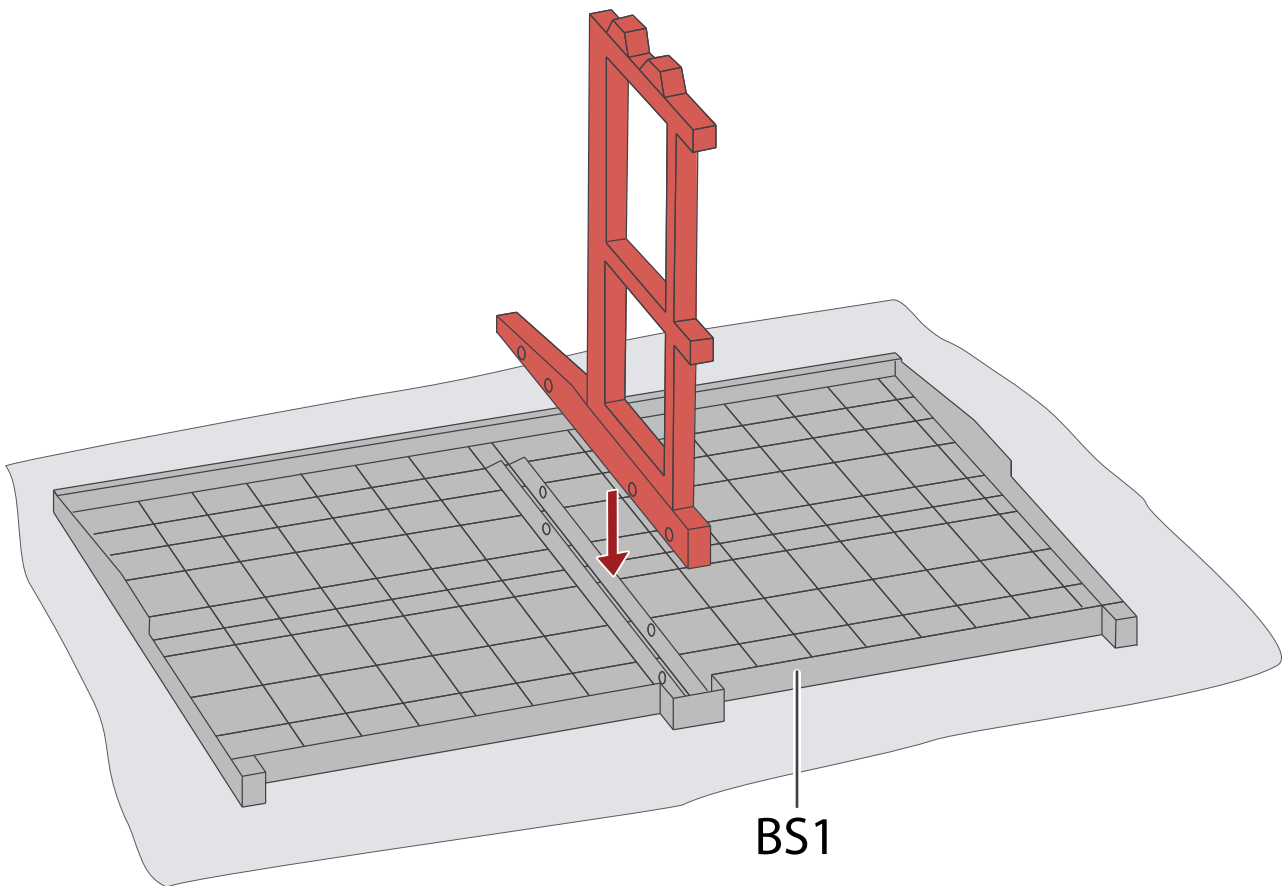

10

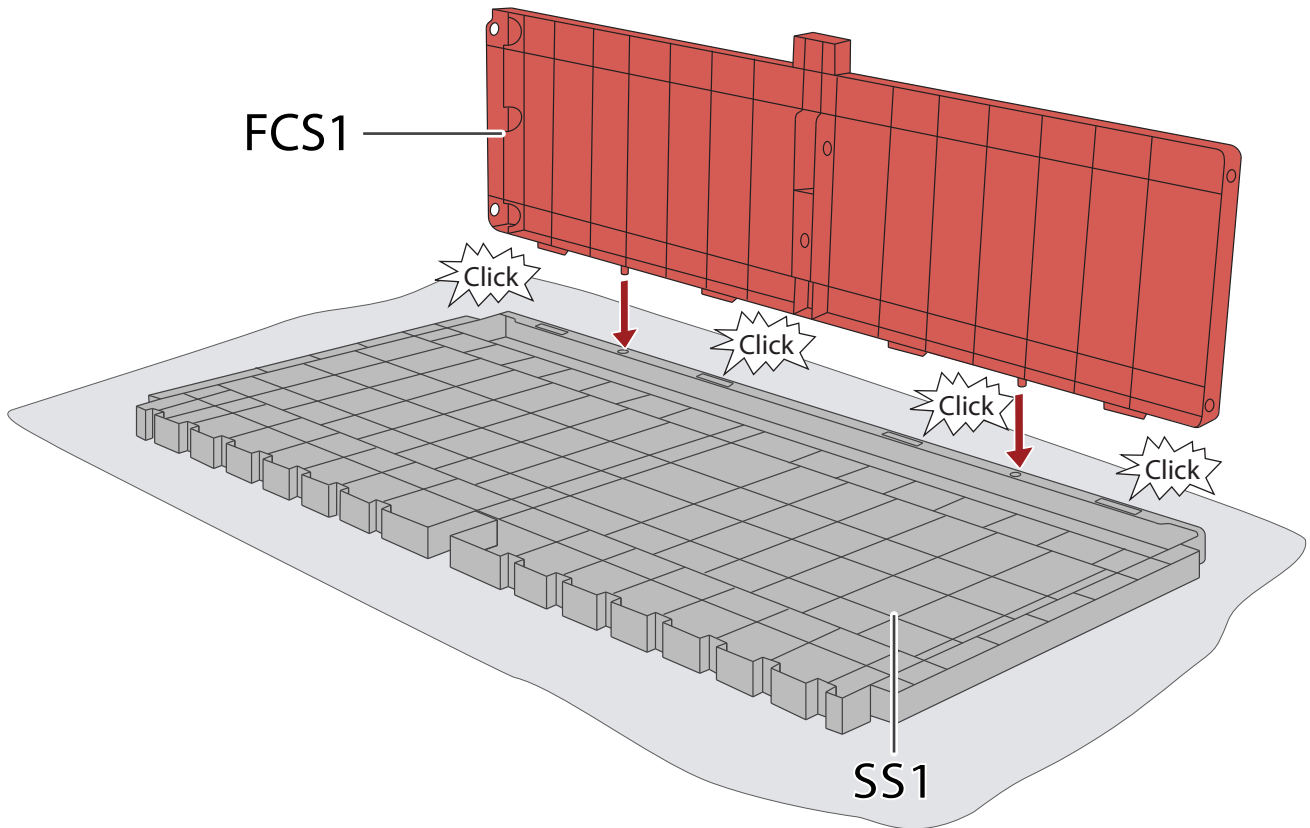
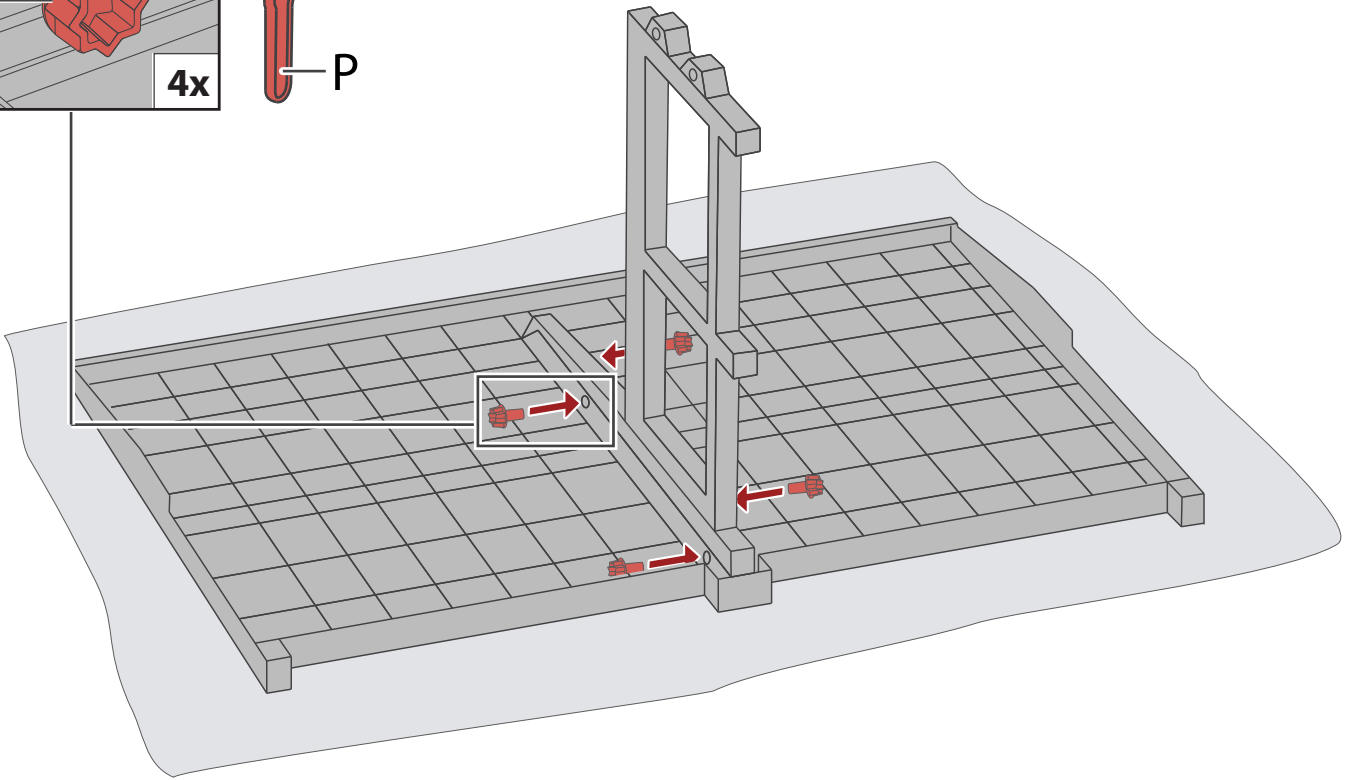
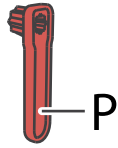
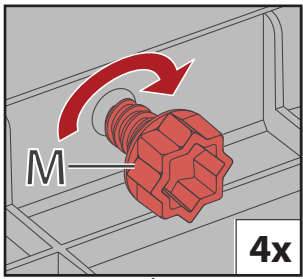

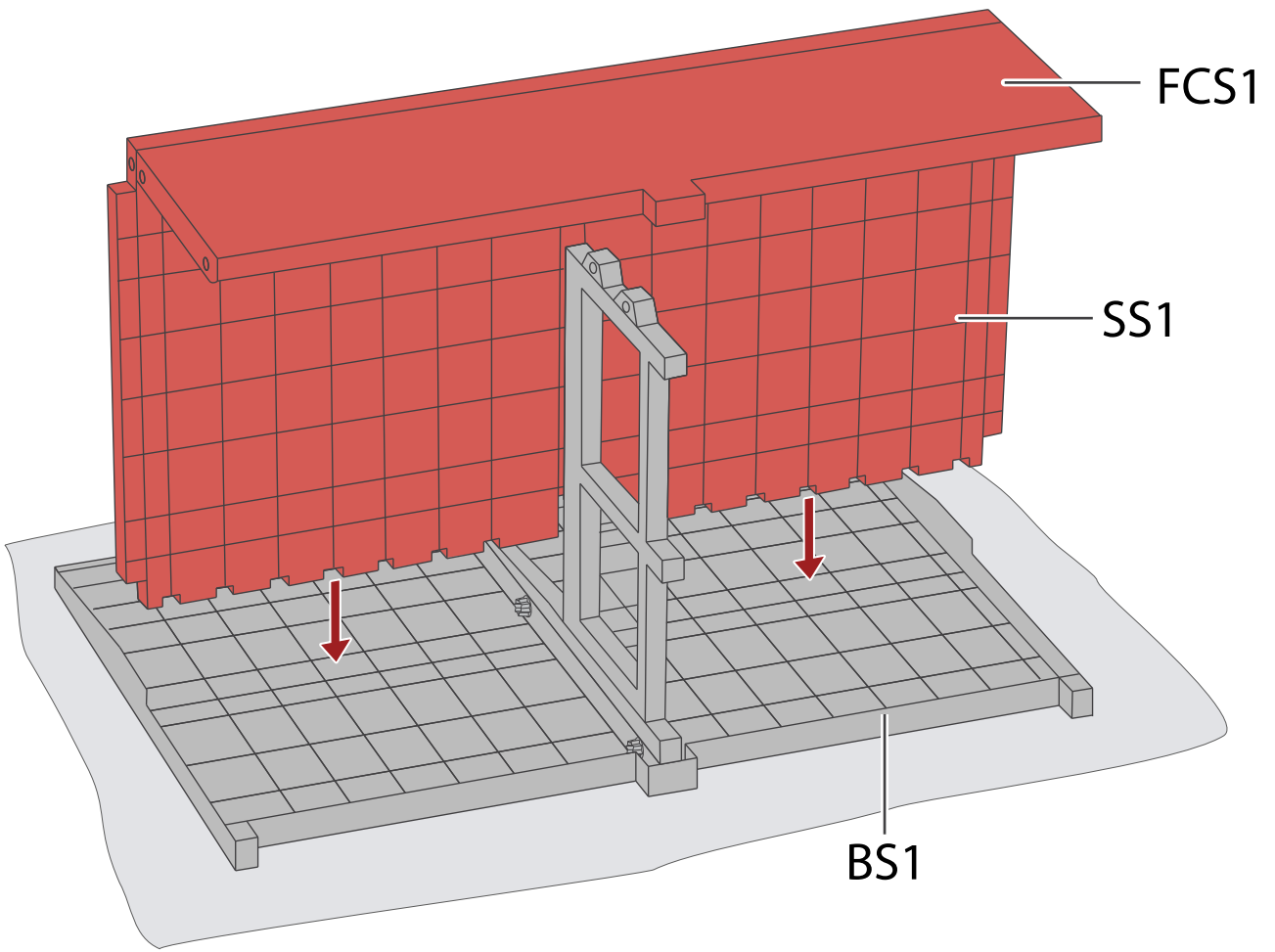

13

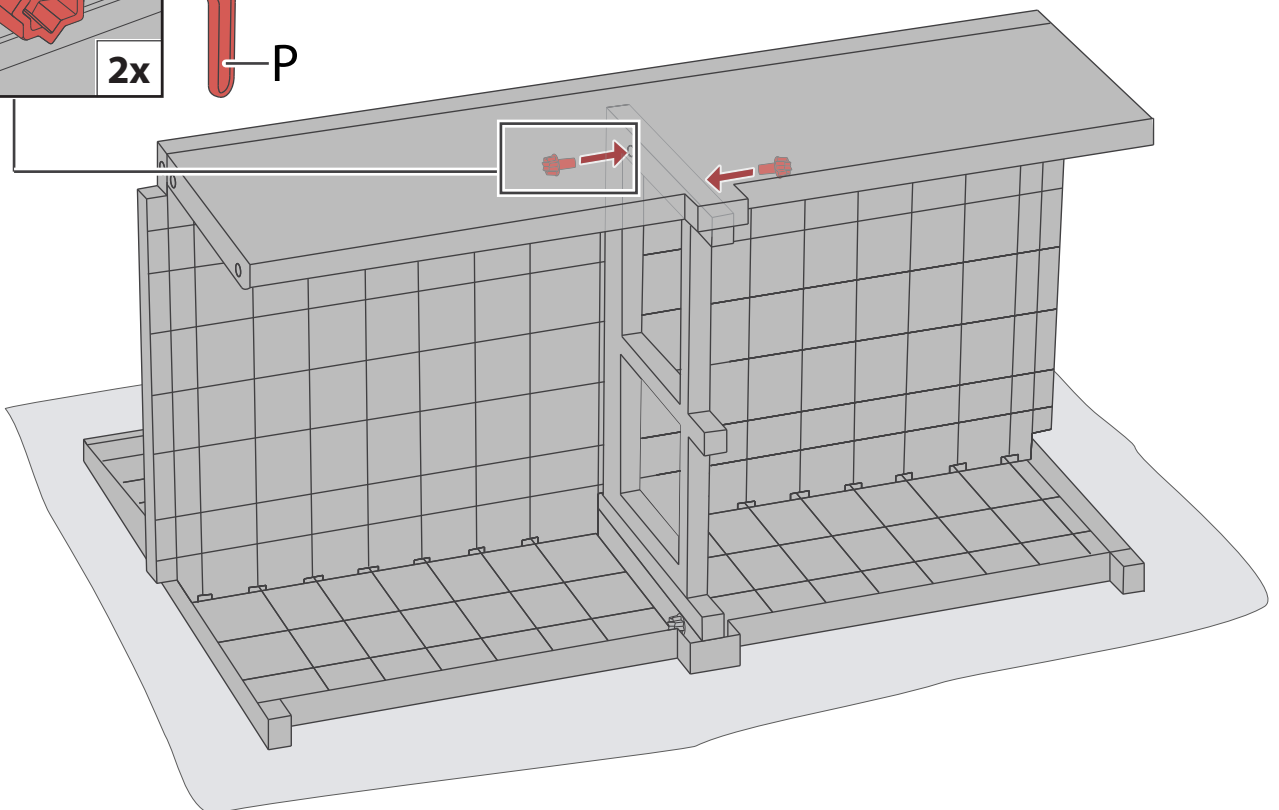
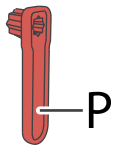
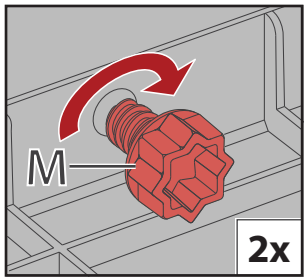

14

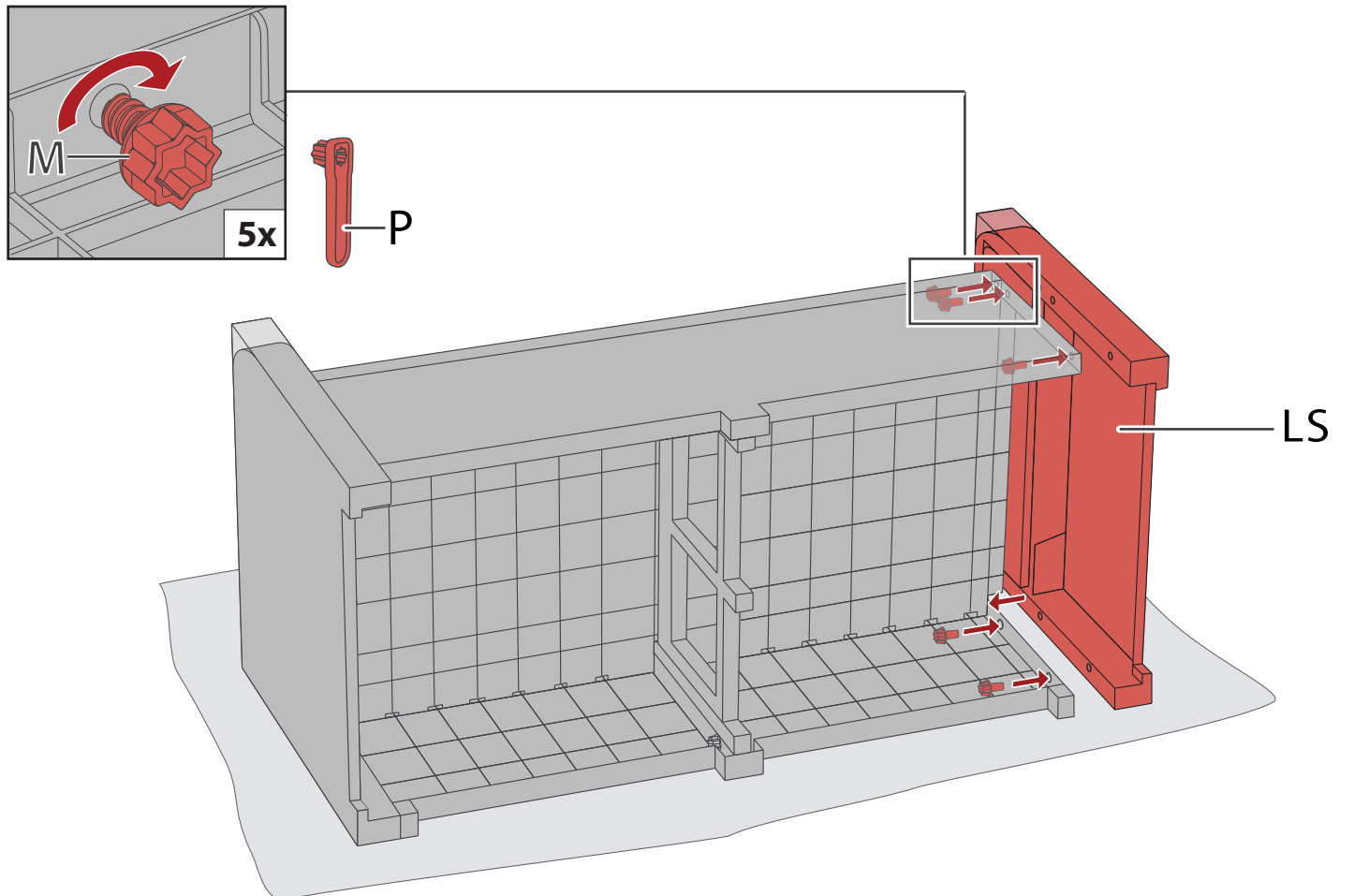
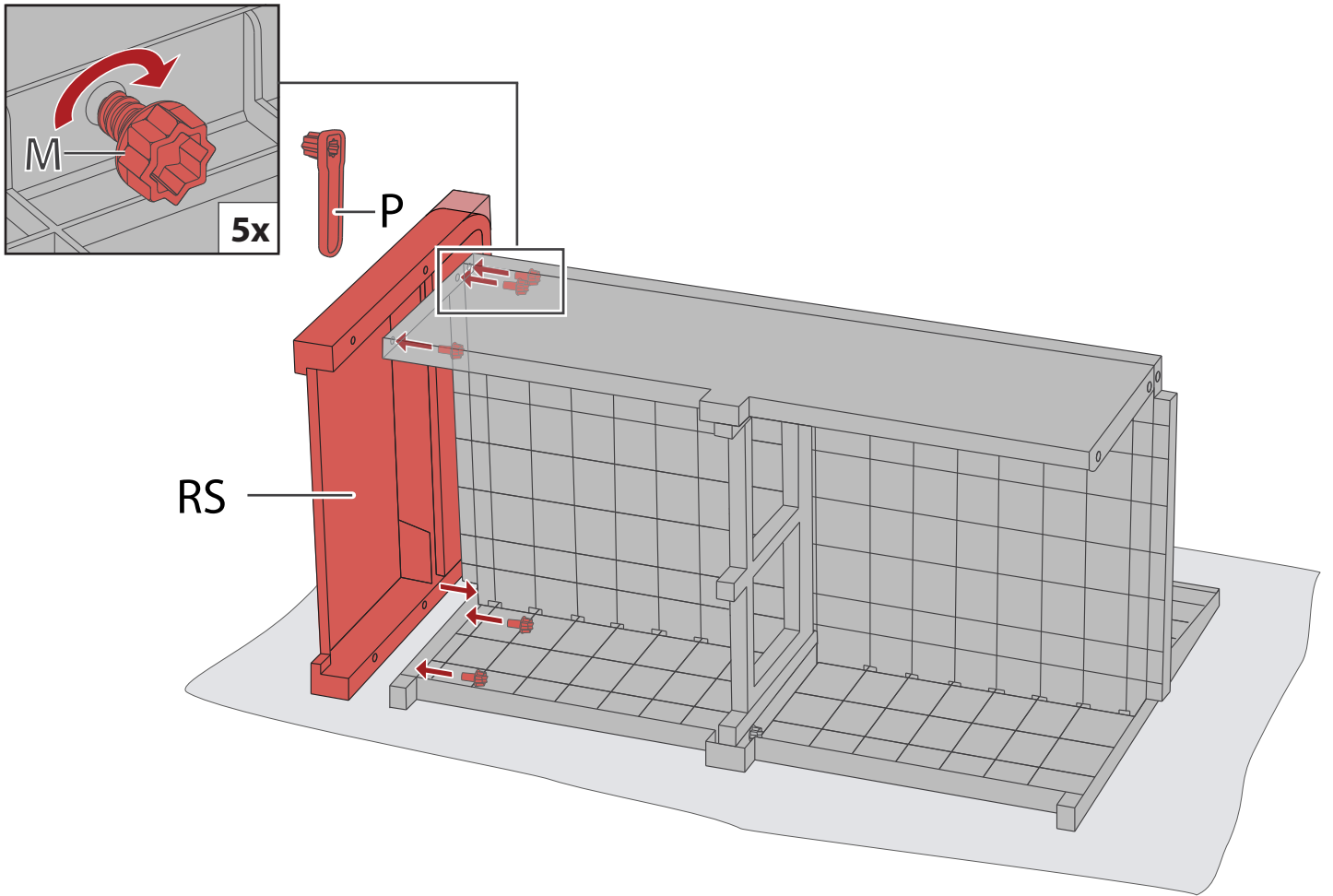

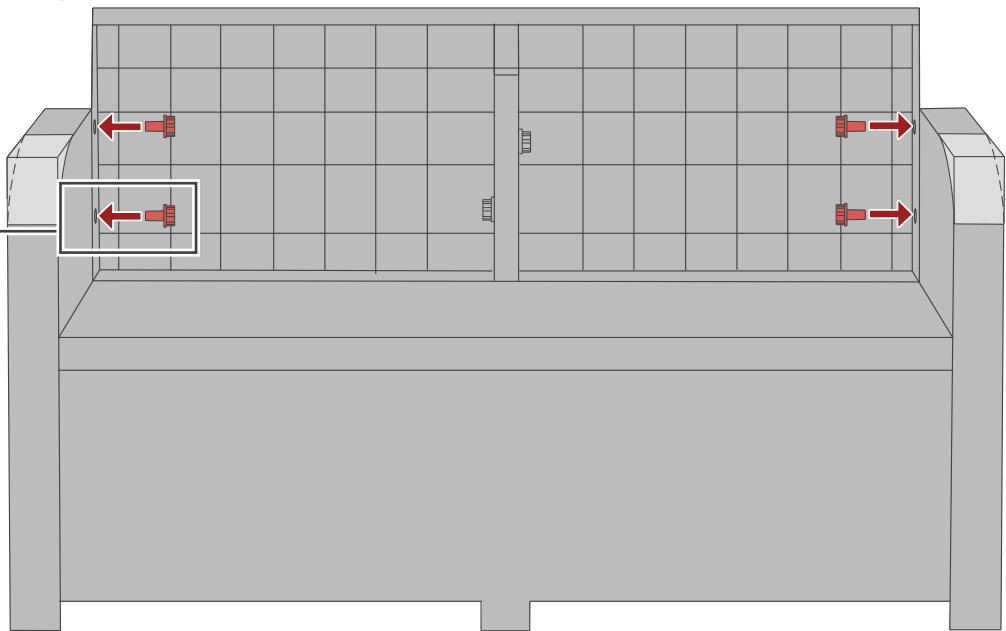
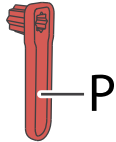
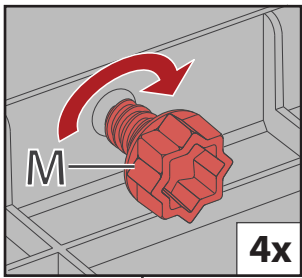

17

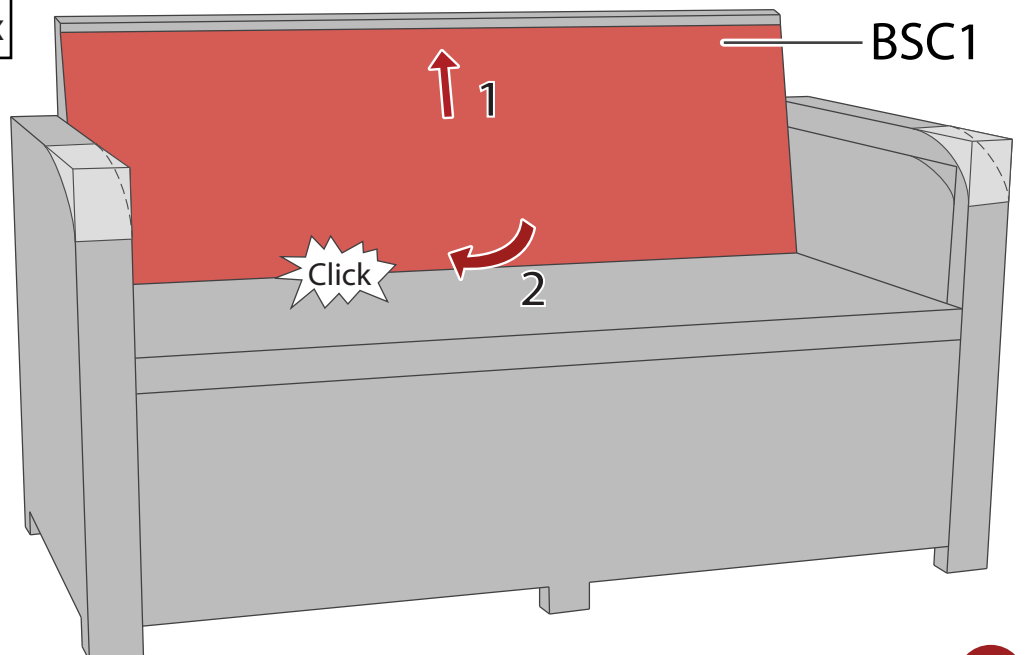
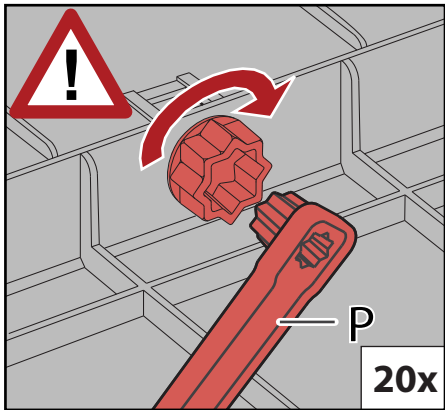

18

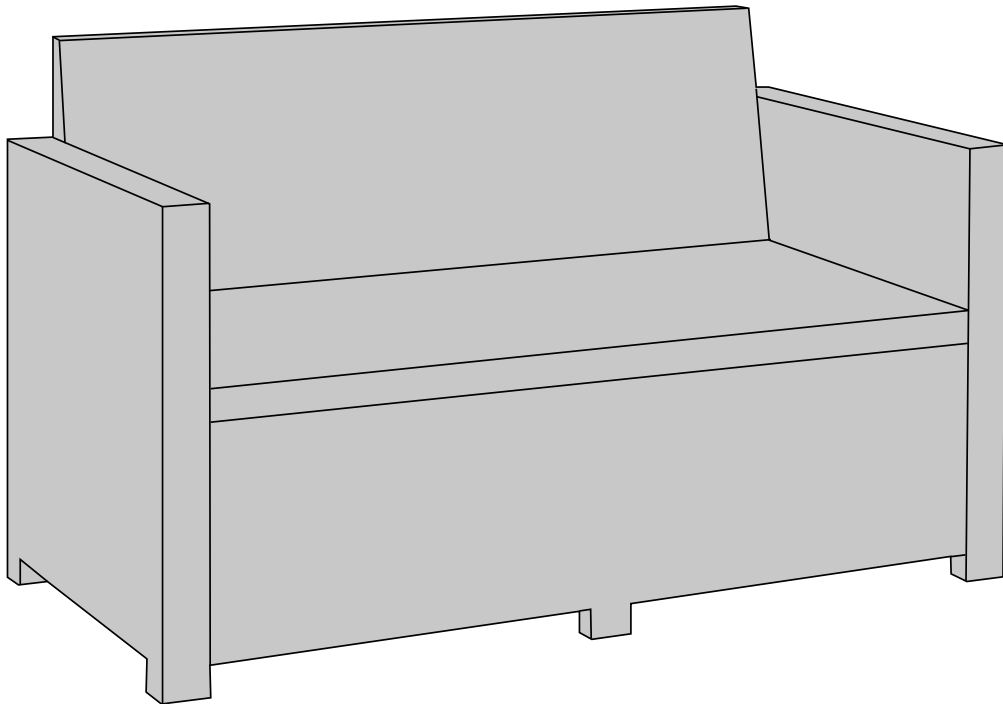
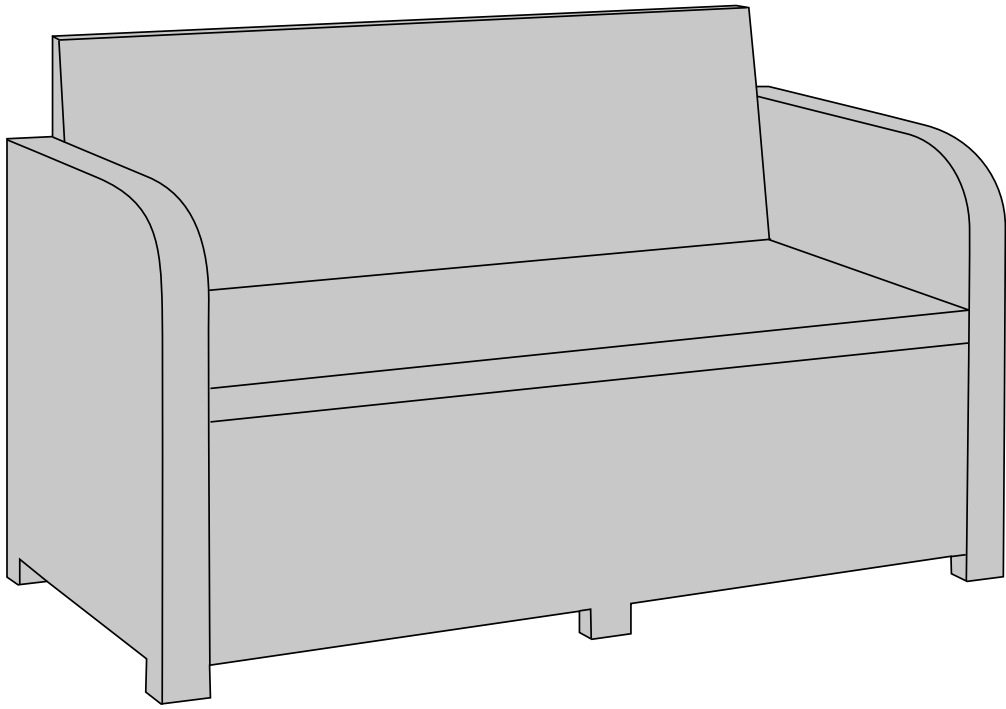

LOUNGE TABLE

93 x 59 cm

9012



59 x 59 cm

9019

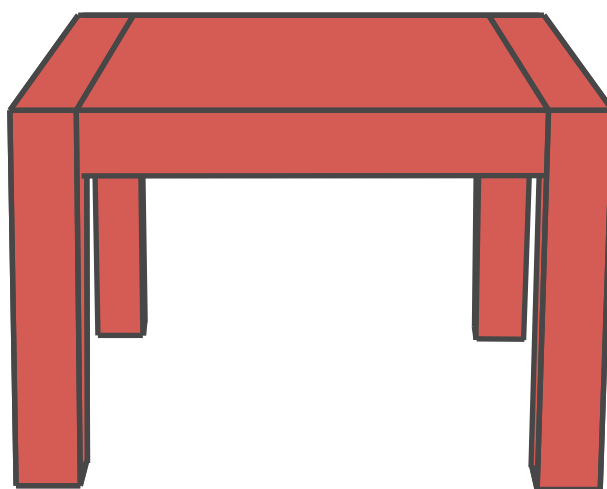



NEN 581

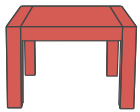

59x59cm

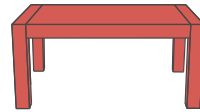

93x59cm

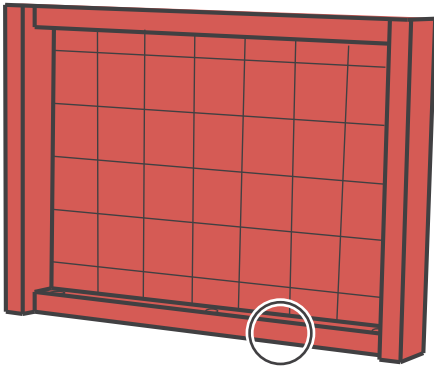

TTS (1x)

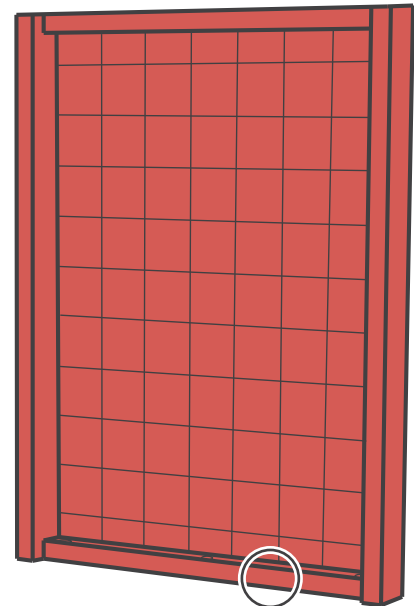

TT (1x)

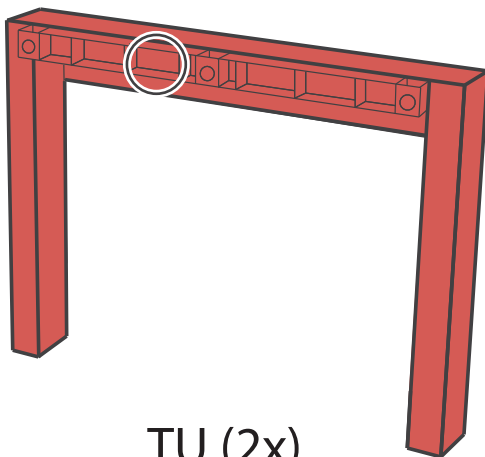

TU (2x)

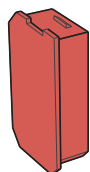

NA (2x)

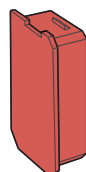

NB (2x)

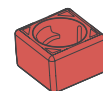
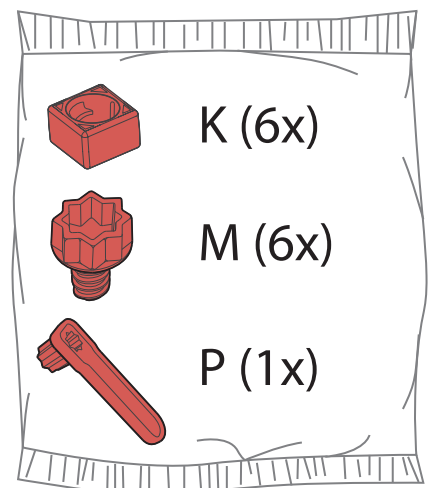

K (6x)

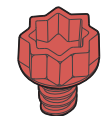

M (6x)

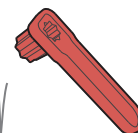

P (1x)

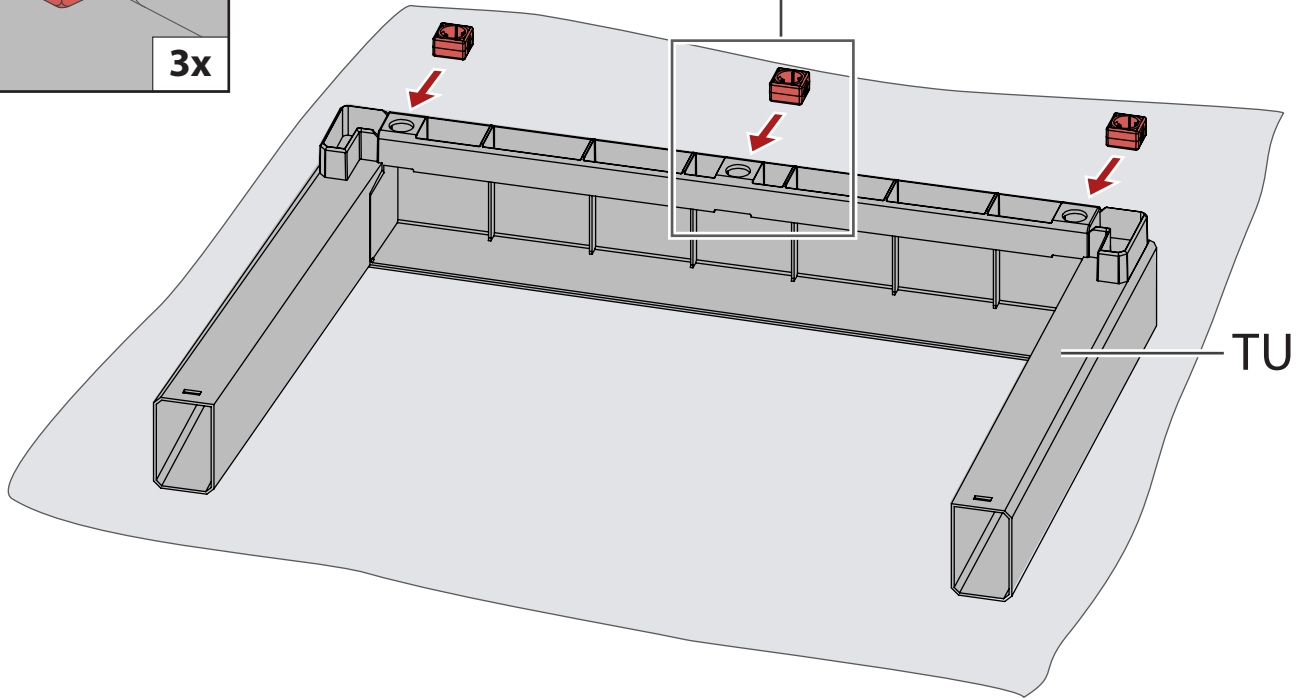
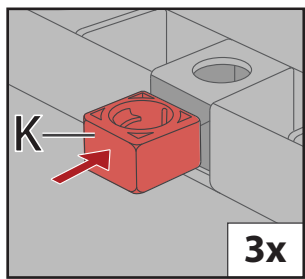

2x

1

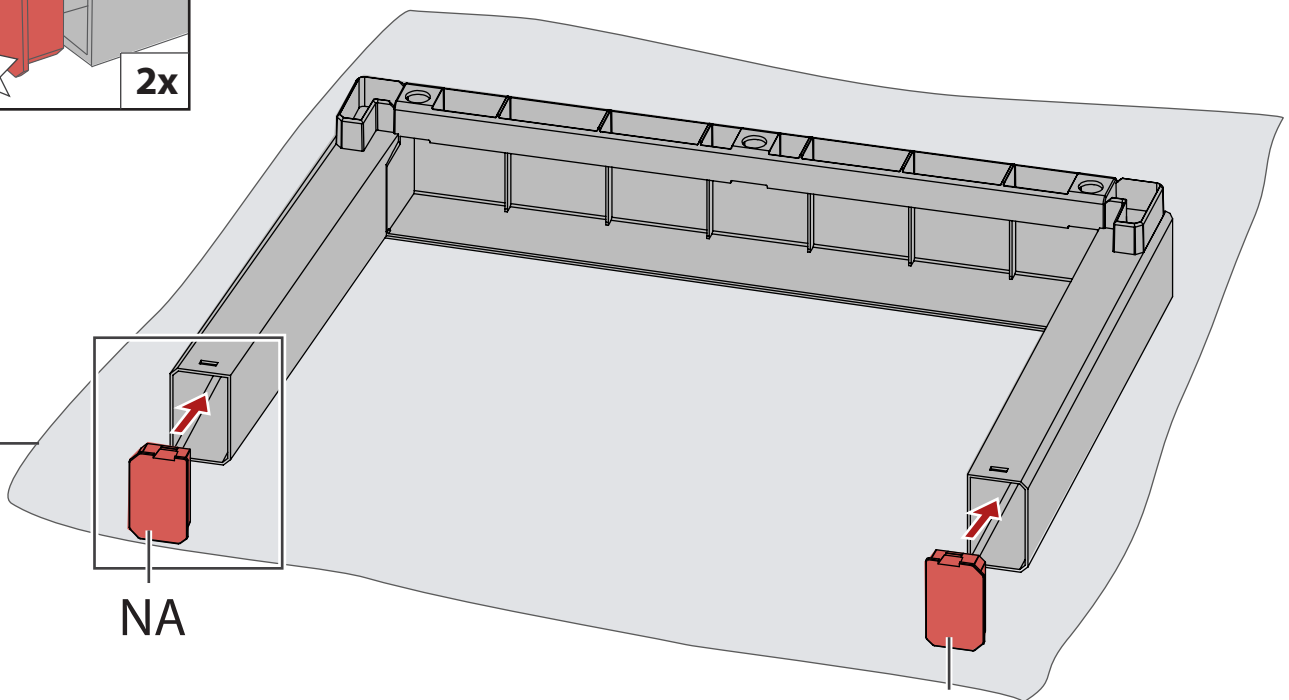
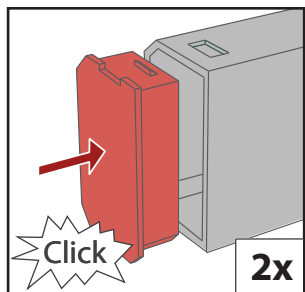

2x

2

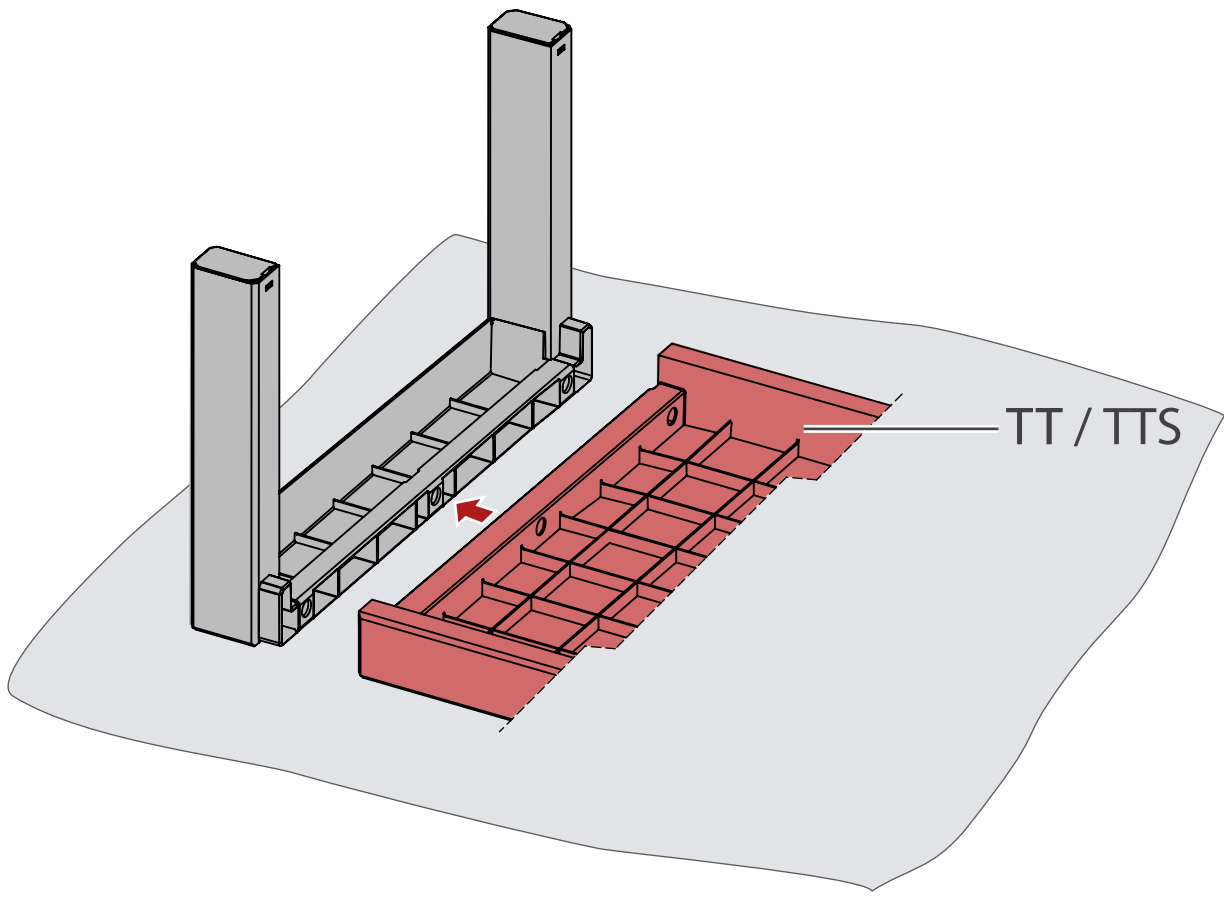

3

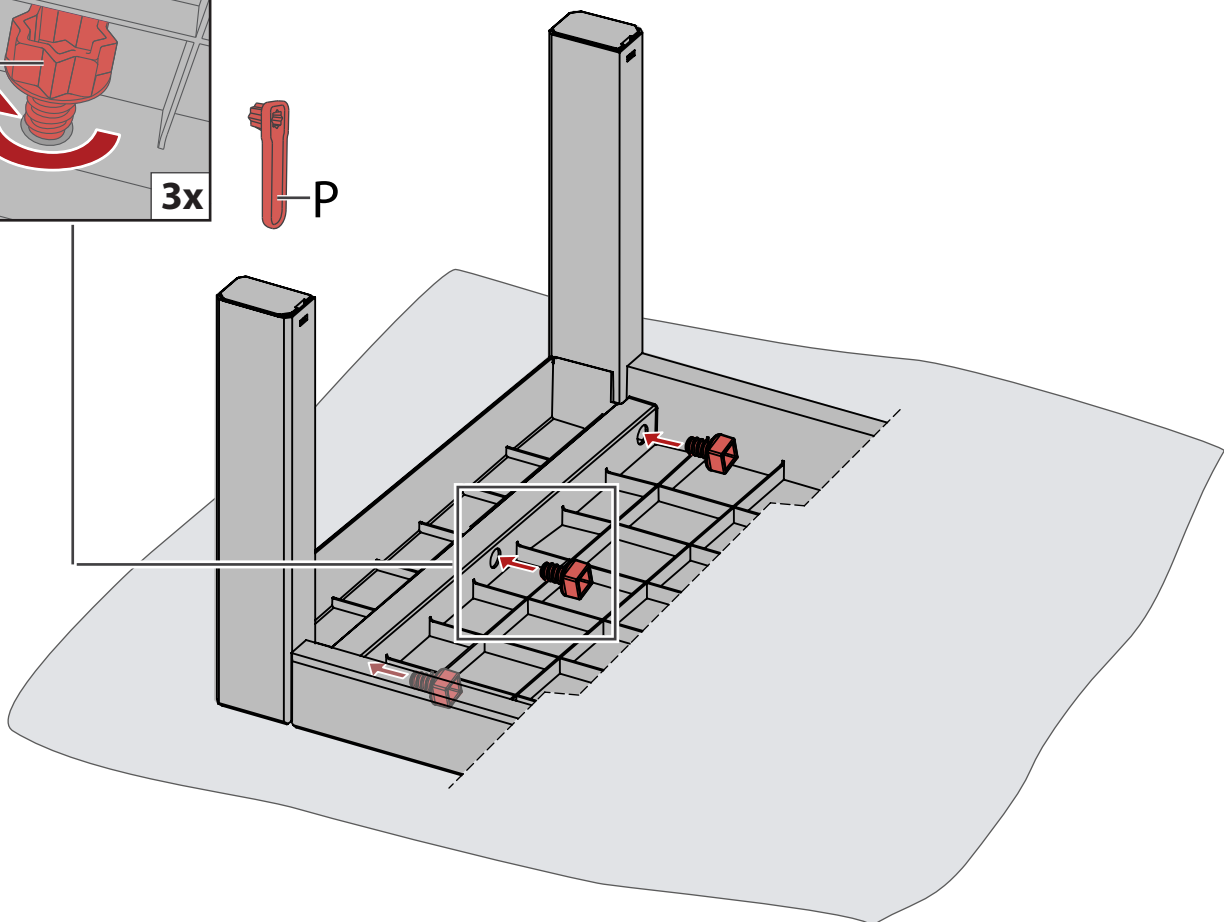
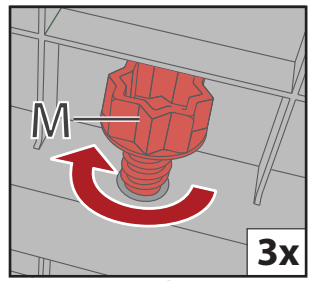

4

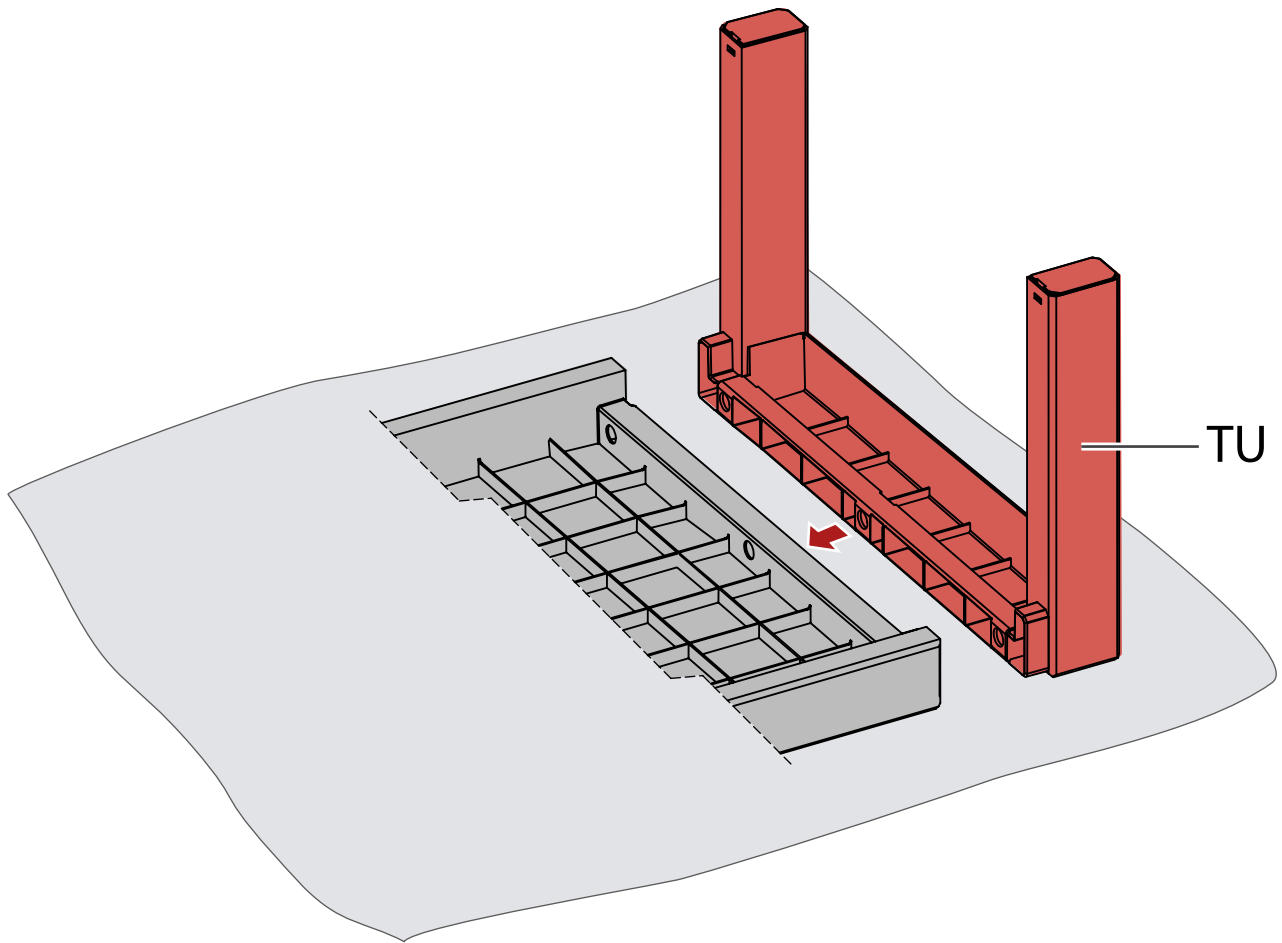

5

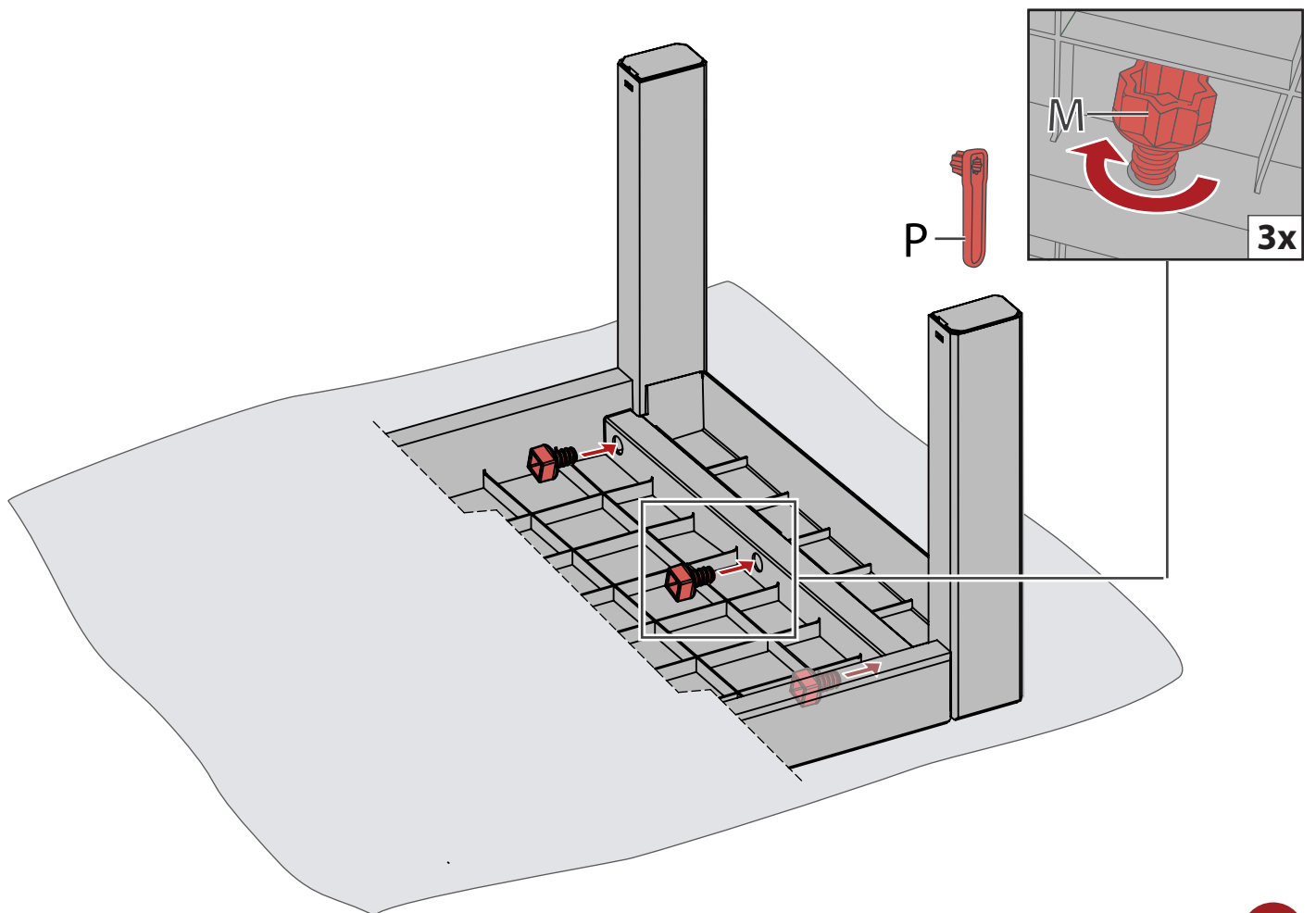

6

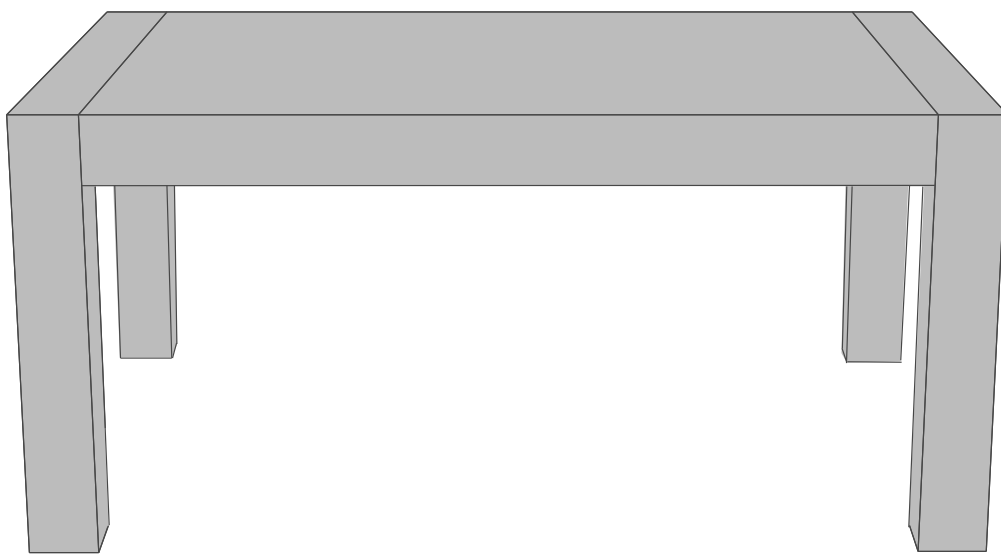

93x59cm

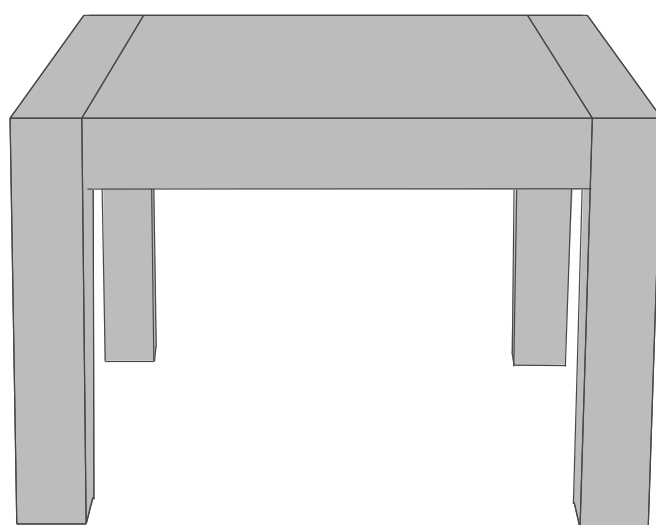

59x59cm
