

CF434-1AL

ALU DRIVHUS Monteringsvejledning

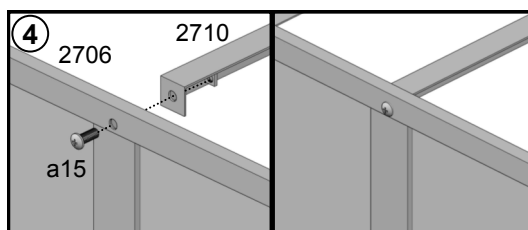

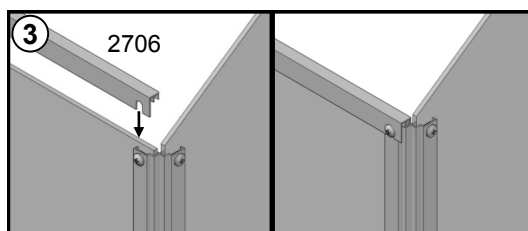
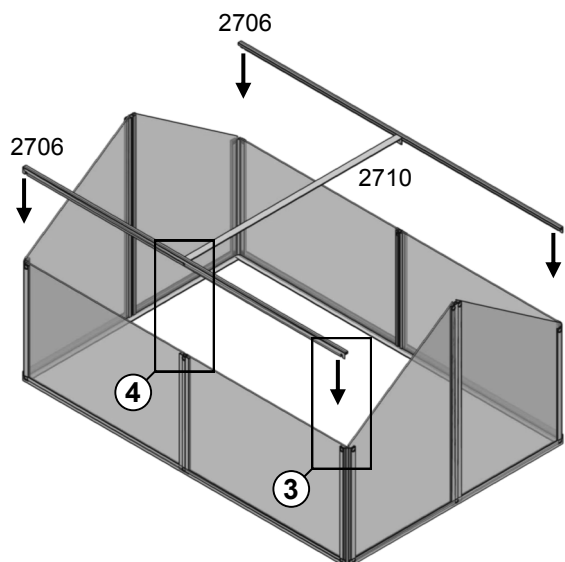
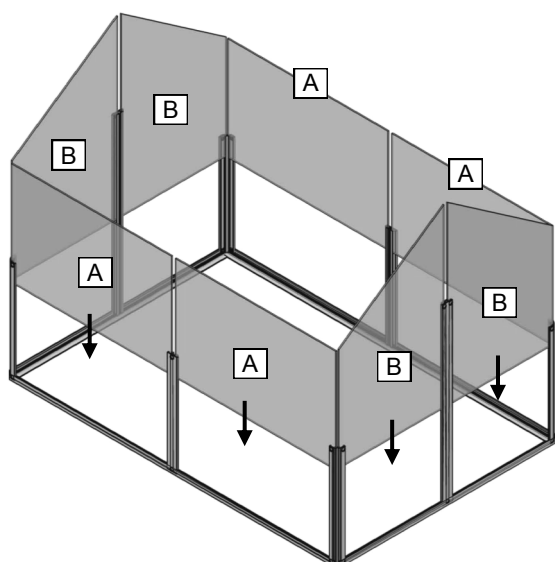
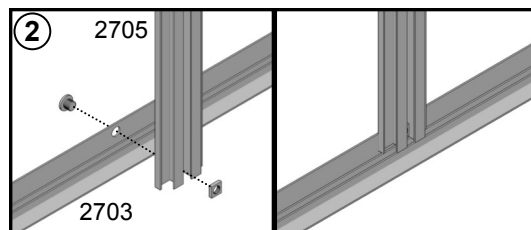
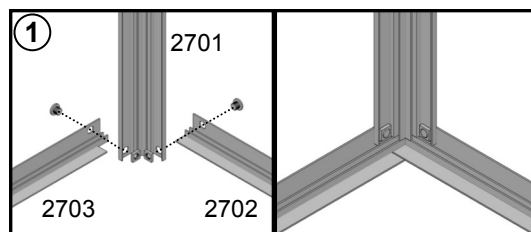
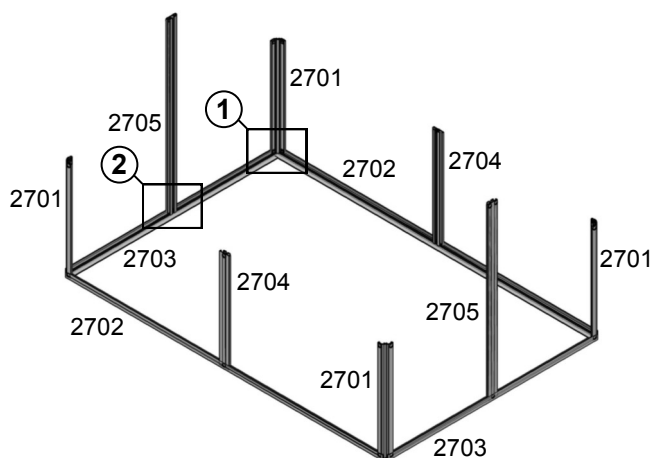
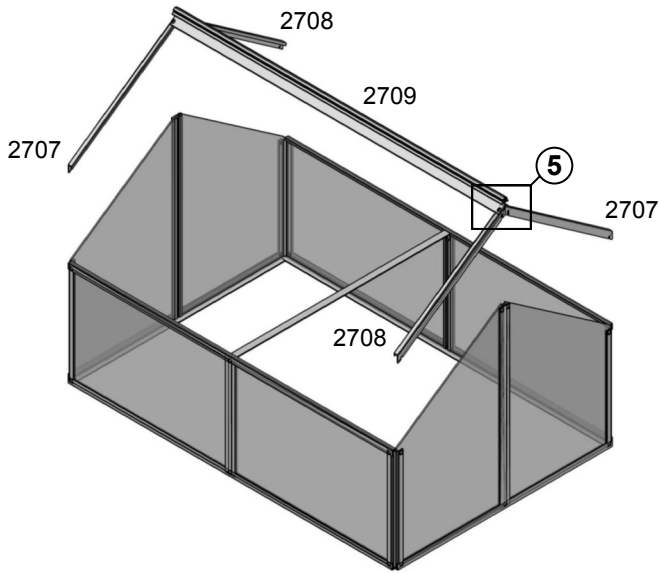

Bemærk : del nr. 2707 og nr. 2708 skal først samles med del nr. 2709, så det udgør taget og dernæst fastmonteres til selve huset

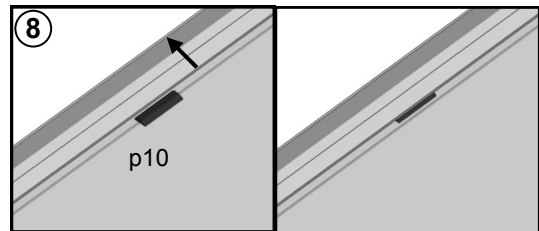
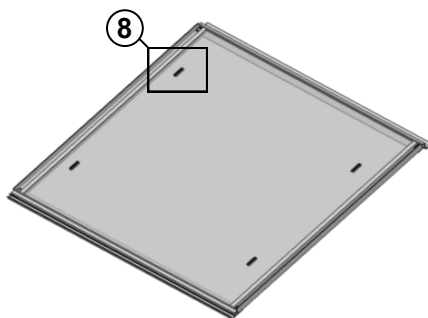
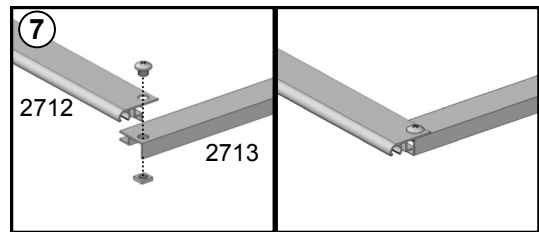
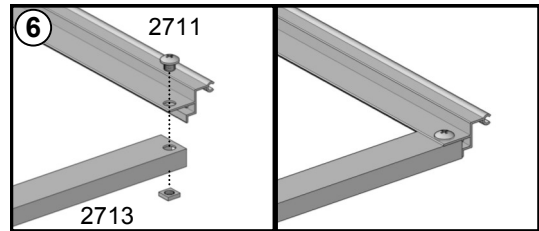
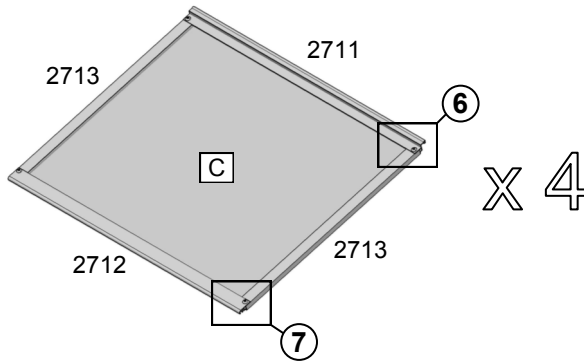
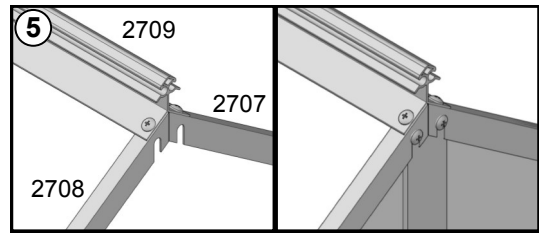



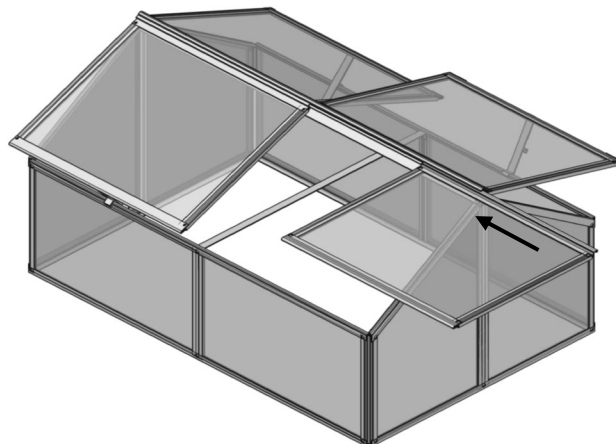

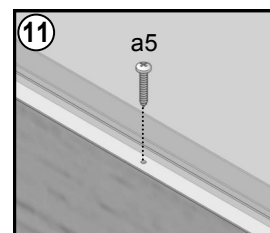
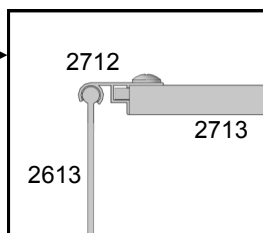
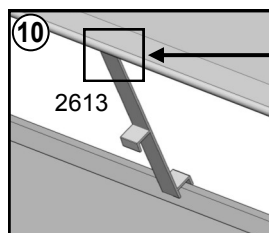
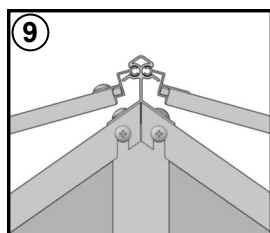
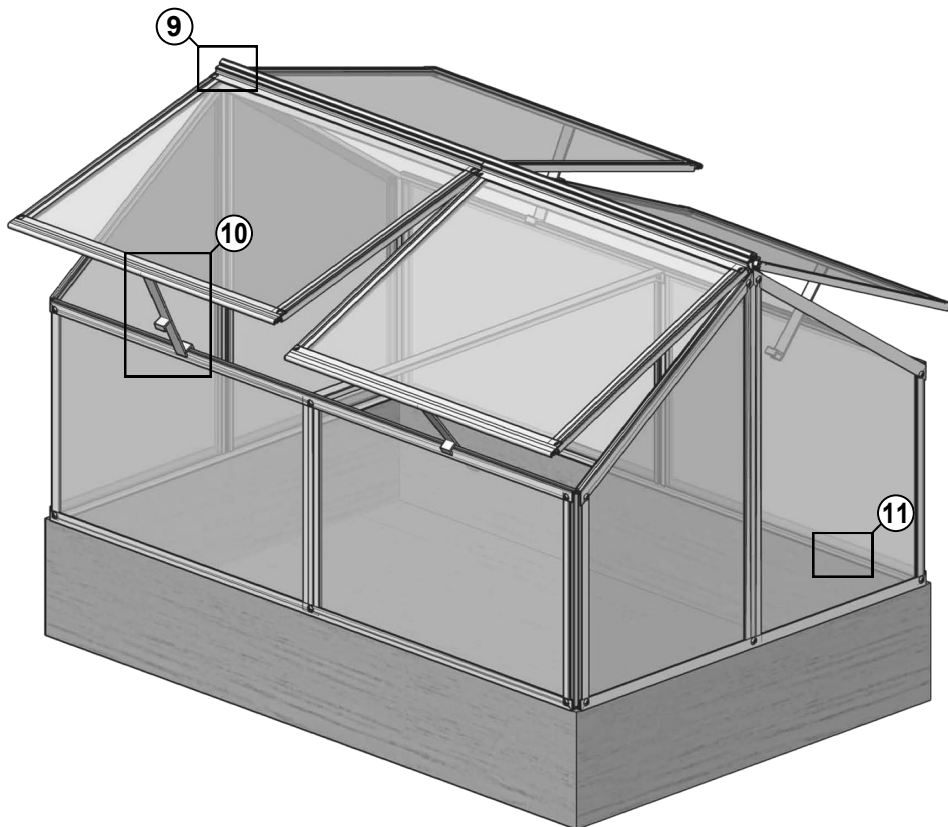











Bemærk : Venligst benyt art. Nr. P10 gummi pakning (klip pakningen til i længder af 20,0 mm) til at lægge i tag rammens liste, så disse er imellem aluminium rammens og glasset på den inderste del af rammens, så glasset hviler på gummi pakningerne. Der benyttes 4 stykker pakning pr. tag vindue og de placeres tættest på hjørnerne.





Materiale listen

Art. Nr.	Længde (mm)	Skitse	Antal	Art. Nr.	Længde (mm)	Skitse	Antal
2701	364		4	2713	466		8
2702	1179		2	2613	20		4
2703	779		2	a7	M6x4.8		44
2704	364		2	a8	M6		46
2705	629		2	a15	M6x15		2
2706	1179		2	a5	Φ3.5x19		12
2707	488		2	-	-		1
2708	488		2	p10	350 mm	gummi pakning	1
2709	1198		1				
2710	819		1	A	582x373	Polycarbonat-panel	4
2711	600		4	B	382x373/637		4
2712	600		4	C	572x477	glas	4